

# **VIMA**

***RK-100***

Owner's Manual

**Roland®**

# Here's what the VIMA lets you do

## Sing with your family or friends!

### Enjoy singing together

The VIMA lets you connect two microphones for singing. You can also adjust the tempo of the song for more comfortable singing.

### Enjoy karaoke with a music CD

You can enjoy karaoke by canceling the vocal sounds of a commercially available music CD and singing along. You can also change the key of the song to a pitch that's more comfortable for the singer.

### Apply effects to your voice

You can apply reverberation to your voice for more enjoyable singing, similar to the echo effect often used with karaoke microphones.

## Easy and intuitive operation

### Simple and functional design

The VIMA's buttons are large and clearly labeled, ensuring that operation is easy. The operating buttons are also grouped by function—a sensible design that lets you quickly perform the operation you intend.

### Large display for great visibility and easy operation

Lyrics and various settings are clearly displayed in large characters.

## Perform music

### Play using instrumental sounds suitable for the song

When you play along while listening to one of the VIMA's songs, you can easily select and play instrumental sounds that are suitable for that song.

### Play the melody along with a song

Using not only the songs built into the VIMA, but also SMF music data, you can mute or silence the melody and play it yourself.

## Enjoy music more fully

### Use CD-ROMs made for the VIMA (VIMA TUNES) to increase your repertoire

CD-ROMs made for the VIMA (VIMA TUNES) let you choose from a broad range of musical styles in addition to the 34 songs that are built into the VIMA.

You can sing along with a wide variety of songs, and play along using instrumental sounds that are suitable for each song.

Before using this unit, carefully read the sections entitled: "USING THE UNIT SAFELY" and "IMPORTANT NOTES" (pp.6–9). These sections provide important information concerning the proper operation of the unit. Additionally, in order to feel assured that you have gained a good grasp of every feature provided by your new unit, Owner's manual should be read in its entirety. The manual should be saved and kept on hand as a convenient reference.

Copyright © 2006 ROLAND CORPORATION

All rights reserved. No part of this publication may be reproduced in any form without the written permission of ROLAND CORPORATION.

# Introduction

Thank you, and congratulations on your choice of the VIMA (RK-100). To ensure that you obtain the maximum enjoyment and take full advantage of the VIMA's functionality, please read this owner's manual carefully.

## About the manual

The owner's manual explains the basic operations you should understand in order to use the VIMA's performance capability, as well as more advanced operations that let you connect various equipment to the VIMA so that you can enjoy music and video.

## Conventions in this manual

In order to explain the operations as clearly as possible, this manual uses the following conventions.

- Text enclosed in square brackets [ ] indicates the name of a controller, such as the [ECHO] button.
- Text enclosed in angle brackets < > indicates text that appears in the screen, such as <Tone List>.
- Lines that begin with **Note** or an asterisk \* are cautionary statements that you must be sure to read.
- The numbers of pages that you can turn to for additional, related information are given like this: (p. \*\*).

# Contents

<b>Introduction .....</b>	<b>3</b>
About the manual .....	3
Conventions in this manual .....	3
<b>USING THE UNIT SAFELY .....</b>	<b>6</b>
<b>IMPORTANT NOTES .....</b>	<b>8</b>
<b>Names of things and what they do .....</b>	<b>10</b>
<b>Before you play .....</b>	<b>14</b>
Getting ready to play .....	14
Connecting the power cord .....	14
Turning the power on/off .....	14
Adjusting the volume .....	15
Attaching the music rest .....	15
Listening through headphones .....	16
Adjusting the brightness of the display .....	16
<b>Listening on the VIMA .....</b>	<b>17</b>
Songs you can play using the VIMA .....	17
Listening to the demo song .....	18
Listening to internal songs .....	19
Changing the tempo of a song .....	21
Listening to songs from a CD-ROM .....	22
Listening to songs from a music CD .....	26
Listening to songs saved in "Favorites" .....	30
Saving a song in "Favorites" (Copy) .....	30
Playing a song from "Favorites" .....	31
Deleting a song from "Favorites" .....	32
<b>Playing the VIMA .....</b>	<b>33</b>
Selecting the sound played from the keyboard .....	33
Playing sound effects or percussion instruments from the keyboard .....	34
Performing with sounds that match the song (Recommended Tone) .....	35
Sounding a count to keep your timing accurate .....	37
Adjusting the volume balance between the song and keyboard .....	38
Using an expression pedal to make your performance expressive .....	39
Using a damper pedal to play smoothly .....	40
Muting the melody from a song (Melody Mute) .....	41
Playing while you listen to the song melody (Melody Guide) .....	42
Performing with your favorite sounds (Tone List) .....	43
Selecting instruments .....	43

---

<b>Singing along with the VIMA.....</b>	<b>45</b>
Connecting a microphone.....	45
Adjusting the volume of the microphone .....	46
Changing the song to a key that's comfortable for singing (Key Control).....	47
Adding echo to vocals.....	48
Enjoying karaoke with a commercially available music CD (Center Cancel) .....	49
<b>Connecting other equipment.....</b>	<b>50</b>
Connecting audio equipment .....	50
Playing the VIMA through connected speakers .....	50
Playing the sound of an audio device through the VIMA.....	51
Connecting a television .....	52
Connecting MIDI equipment.....	53
Using a MIDI sequencer to play the VIMA .....	53
Playing a MIDI sound module from the VIMA .....	53
Connecting your computer .....	54
<b>Settings .....</b>	<b>55</b>
Playing the recommended sounds (Recommended Tone).....	55
Playing desired sounds (Tone List) .....	55
Playing all songs consecutively (All Song Play) .....	56
Playing the same song repeatedly (Song Repeat) .....	56
Changing the melody channel (Melody Channel).....	57
Changing the MIDI transmit channel (MIDI Tx Channel) .....	57
USB driver settings (USB Driver).....	58
Restoring the factory-set condition (Factory Reset).....	58
<b>Troubleshooting .....</b>	<b>59</b>
<b>If one of these messages appears .....</b>	<b>63</b>
<b>Tone List .....</b>	<b>64</b>
<b>Internal Song List .....</b>	<b>69</b>
<b>Music Files That the VIMA Can Use .....</b>	<b>70</b>
<b>MIDI Implementation Chart.....</b>	<b>71</b>
<b>Main Specifications .....</b>	<b>72</b>
<b>Index .....</b>	<b>73</b>

# USING THE UNIT SAFELY

## INSTRUCTIONS FOR THE PREVENTION OF FIRE, ELECTRIC SHOCK, OR INJURY TO PERSONS

### About ⚠ WARNING and ⚠ CAUTION Notices

<b>⚠ WARNING</b>	Used for instructions intended to alert the user to the risk of death or severe injury should the unit be used improperly.
<b>⚠ CAUTION</b>	Used for instructions intended to alert the user to the risk of injury or material damage should the unit be used improperly. * Material damage refers to damage or other adverse effects caused with respect to the home and all its furnishings, as well to domestic animals or pets.

### About the Symbols

	The ⚠ symbol alerts the user to important instructions or warnings. The specific meaning of the symbol is determined by the design contained within the triangle. In the case of the symbol at left, it is used for general cautions, warnings, or alerts to danger.
	The ⚡ symbol alerts the user to items that must never be carried out (are forbidden). The specific thing that must not be done is indicated by the design contained within the circle. In the case of the symbol at left, it means that the unit must never be disassembled.
	The ⚡ symbol alerts the user to things that must be carried out. The specific thing that must be done is indicated by the design contained within the circle. In the case of the symbol at left, it means that the power-cord plug must be unplugged from the outlet.

## ALWAYS OBSERVE THE FOLLOWING

### ⚠ WARNING

- Before using this unit, make sure to read the instructions below, and the Owner's Manual.

---

- Do not open (or modify in any way) the unit or its AC adaptor.

---

- Do not attempt to repair the unit, or replace parts within it (except when this manual provides specific instructions directing you to do so). Refer all servicing to your retailer, the nearest Roland Service Center, or an authorized Roland distributor, as listed on the "Information" page.

---

- Never use or store the unit in places that are:
  - Subject to temperature extremes (e.g., direct sunlight in an enclosed vehicle, near a heating duct, on top of heat-generating equipment); or are
  - Damp (e.g., baths, washrooms, on wet floors); or are
  - Humid; or are
  - Exposed to rain; or are
  - Dusty; or are
  - Subject to high levels of vibration.

---

- This unit should be used only with a stand that is recommended by Roland.

---

- When using the unit with a rack recommended by Roland, the stand must be carefully placed so it is level and sure to remain stable. If not using a stand, you still need to make sure that any location you choose for placing the unit provides a level surface that will properly support the unit, and keep it from wobbling.

### ⚠ WARNING

- Be sure to use only the AC adaptor supplied with the unit. Also, make sure the line voltage at the installation matches the input voltage specified on the AC adaptor's body. Other AC adaptors may use a different polarity, or be designed for a different voltage, so their use could result in damage, malfunction, or electric shock.

---

- Do not excessively twist or bend the power cord, nor place heavy objects on it. Doing so can damage the cord, producing severed elements and short circuits. Damaged cords are fire and shock hazards!

---

- This unit, either alone or in combination with an amplifier and headphones or speakers, may be capable of producing sound levels that could cause permanent hearing loss. Do not operate for a long period of time at a high volume level, or at a level that is uncomfortable. If you experience any hearing loss or ringing in the ears, you should immediately stop using the unit, and consult an audiologist.

---

- Do not allow any objects (e.g., flammable material, coins, pins); or liquids of any kind (water, soft drinks, etc.) to penetrate the unit.

## ⚠ WARNING

- Immediately turn the power off, remove the AC adaptor from the outlet, and request servicing by your retailer, the nearest Roland Service Center, or an authorized Roland distributor, as listed on the "Information" page when:
  - The AC adaptor or the power-supply cord has been damaged; or
  - If smoke or unusual odor occurs
  - Objects have fallen into, or liquid has been spilled onto the unit; or
  - The unit has been exposed to rain (or otherwise has become wet); or
  - The unit does not appear to operate normally or exhibits a marked change in performance.
- In households with small children, an adult should provide supervision until the child is capable of following all the rules essential for the safe operation of the unit.
- Protect the unit from strong impact. (Do not drop it!)
- Do not force the unit's power-supply cord to share an outlet with an unreasonable number of other devices. Be especially careful when using extension cords—the total power used by all devices you have connected to the extension cord's outlet must never exceed the power rating (watts/ amperes) for the extension cord. Excessive loads can cause the insulation on the cord to heat up and eventually melt through.
- Before using the unit in a foreign country, consult with your retailer, the nearest Roland Service Center, or an authorized Roland distributor, as listed on the "Information" page.
- DO NOT play a CD-ROM disc on a conventional audio CD player. The resulting sound may be of a level that could cause permanent hearing loss. Damage to speakers or other system components may result.

## ⚠ CAUTION

- The unit and the AC adaptor should be located so their location or position does not interfere with their proper ventilation.
- This (RK-100) for use only with Roland stand KS-RK100. Use with other stands is capable of resulting in instability causing possible injury.
- Always grasp only the output plug or the body of the AC adaptor when plugging into, or unplugging from, this unit or an outlet.
- At regular intervals, you should unplug the AC adaptor and clean it by using a dry cloth to wipe all dust and other accumulations away from its prongs. Also, disconnect the power plug from the power outlet whenever the unit is to remain unused for an extended period of time. Any accumulation of dust between the power plug and the power outlet can result in poor insulation and lead to fire.
- Try to prevent cords and cables from becoming entangled. Also, all cords and cables should be placed so they are out of the reach of children.
- Never climb on top of, nor place heavy objects on the unit.
- Never handle the AC adaptor body, or its output plugs, with wet hands when plugging into, or unplugging from, an outlet or this unit.
- Before moving the unit, disconnect the AC adaptor and all cords coming from external devices.
- Before cleaning the unit, turn off the power and unplug the AC adaptor from the outlet (p. 14).
- Whenever you suspect the possibility of lightning in your area, disconnect the AC adaptor from the outlet.
- Should you remove the grounding screw, keep them in a safe place out of children's reach, so there is no chance of them being swallowed accidentally.

# IMPORTANT NOTES

In addition to the items listed under “USING THE UNIT SAFELY” on page 6, please read and observe the following:

## Power Supply

- Do not connect this unit to same electrical outlet that is being used by an electrical appliance that is controlled by an inverter (such as a refrigerator, washing machine, microwave oven, or air conditioner), or that contains a motor. Depending on the way in which the electrical appliance is used, power supply noise may cause this unit to malfunction or may produce audible noise. If it is not practical to use a separate electrical outlet, connect a power supply noise filter between this unit and the electrical outlet.
- The AC adaptor will begin to generate heat after long hours of consecutive use. This is normal, and is not a cause for concern.
- Before connecting this unit to other devices, turn off the power to all units. This will help prevent malfunctions and/or damage to speakers or other devices.

## Placement

- Using the unit near power amplifiers (or other equipment containing large power transformers) may induce hum. To alleviate the problem, change the orientation of this unit; or move it farther away from the source of interference.
- This device may interfere with radio and television reception. Do not use this device in the vicinity of such receivers.
- Noise may be produced if wireless communications devices, such as cell phones, are operated in the vicinity of this unit. Such noise could occur when receiving or initiating a call, or while conversing. Should you experience such problems, you should relocate such wireless devices so they are at a greater distance from this unit, or switch them off.
- Do not expose the unit to direct sunlight, place it near devices that radiate heat, leave it inside an enclosed vehicle, or otherwise subject it to temperature extremes. Excessive heat can deform or discolor the unit.
- When moved from one location to another where the temperature and/or humidity is very different, water droplets (condensation) may form inside the unit. Damage or malfunction may result if you attempt to use the unit in this condition. Therefore, before using the unit, you must allow it to stand for several hours, until the condensation has completely evaporated.
- Do not allow objects to remain on top of the keyboard. This can be the cause of malfunction, such as keys ceasing to produce sound.
- Depending on the material and temperature of the surface on which you place the unit, its rubber feet may discolor or mar the surface. You can place a piece of felt or cloth under the rubber feet to prevent this from happening. If you do so, please make sure that the unit will not slip or move accidentally.

## Maintenance

- For everyday cleaning wipe the unit with a soft, dry cloth or one that has been slightly dampened with water. To remove stubborn dirt, use a cloth impregnated with a mild, non-abrasive detergent. Afterwards, be sure to wipe the unit thoroughly with a soft, dry cloth.
- Never use benzine, thinners, alcohol or solvents of any kind, to avoid the possibility of discoloration and/or deformation.

## Handling CD-ROMs



- Avoid touching or scratching the shiny underside (encoded surface) of the disc. Damaged or dirty CD-ROM discs may not be read properly. Keep your discs clean using a commercially available CD cleaner.

## Repairs and Data

- Please be aware that all data contained in the unit's memory may be lost when the unit is sent for repairs. Important data should always be written down on paper (when possible). During repairs, due care is taken to avoid the loss of data. However, in certain cases (such as when circuitry related to memory itself is out of order), we regret that it may not be possible to restore the data, and Roland assumes no liability concerning such loss of data.



## Additional Precautions

- Please be aware that the contents of memory can be irretrievably lost as a result of a malfunction, or the improper operation of the unit. To protect yourself against the risk of losing important data, we recommend that you periodically save a backup copy of important data you have stored in the unit's memory by writing down on paper (when possible).
  - Unfortunately, it may be impossible to restore the contents of data that was stored in the unit's memory once it has been lost. Roland Corporation assumes no liability concerning such loss of data.
  - Use a reasonable amount of care when using the unit's buttons, sliders, or other controls; and when using its jacks and connectors. Rough handling can lead to malfunctions.
  - Never strike or apply strong pressure to the display.
  - When connecting / disconnecting all cables, grasp the connector itself—never pull on the cable. This way you will avoid causing shorts, or damage to the cable's internal elements.
  - To avoid disturbing your neighbors, try to keep the unit's volume at reasonable levels. You may prefer to use headphones, so you do not need to be concerned about those around you (especially when it is late at night).
  - When you need to transport the unit, package it in the box (including padding) that it came in, if possible. Otherwise, you will need to use equivalent packaging materials.
  - Do not apply undue force to the music rest while it is in use.
  - Use only the specified expression pedal (EV-5; sold separately). By connecting any other expression pedals, you risk causing malfunction and/or damage to the unit.
  - Some connection cables contain resistors. Do not use cables that incorporate resistors for connecting to this unit. The use of such cables can cause the sound level to be extremely low, or impossible to hear. For information on cable specifications, contact the manufacturer of the cable.
  - The explanations in this manual include illustrations that depict what should typically be shown by the display. Note, however, that your unit may incorporate a newer, enhanced version of the system (e.g., includes newer sounds), so what you actually see in the display may not always match what appears in the manual.
- \* GS (  ) is a registered trademark of Roland Corporation.
  - \* XG lite (  ) is a registered trademark of Yamaha Corporation.
  - \* Microsoft and Windows are registered trademarks of Microsoft Corporation.
  - \* Windows® is known officially as: "Microsoft® Windows® operating system."
  - \* Apple and Macintosh are registered trademarks of Apple Computer, Inc.
  - \* Mac OS is a trademark of Apple Computer, Inc.
  - \* All product names mentioned in this document are trademarks or registered trademarks of their respective owners.

# Names of things and what they do

## Top Panel

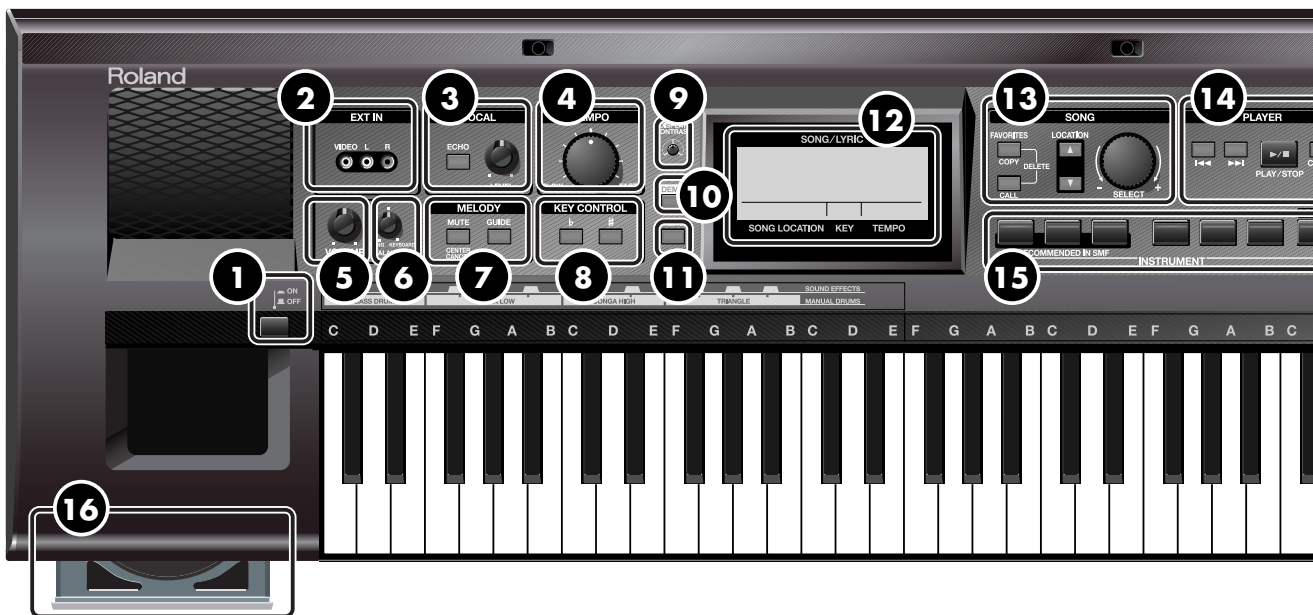

### 1 [Power On] switch

Turns the power on/off (p. 14).

### 2 EXT IN

Here you can connect a DVD player or other video device, and view the images on an external display or play back music (p. 51, p. 52).

### 3 VOCAL

Here you can apply echo to the sound from the microphone (p. 48), and adjust the microphone volume (p. 46).

### 4 [TEMPO] knob

Adjusts the tempo of the song (p. 21).  
Allows you to change the tempo of a song so it's easier to sing or play.

### 5 [VOLUME] knob

Adjusts the overall volume of the VIMA (p. 15).  
If headphones are connected, this adjusts the headphone volume (p. 16).

### 6 [BALANCE] knob

Adjusts the volume balance between the song and the keyboard (p. 38).  
When playing along with a song, you can use this to turn down the song volume.

### 7 MELODY

Here you can soften or mute the melody or vocal sound of a song (p. 41, p. 42).  
You can lower the volume of the melody or vocal of a song and enjoy karaoke, or temporarily mute the melody and play it yourself.

### 8 KEY CONTROL

These buttons let you shift the key of the keyboard or song (p. 47).  
This lets you transpose a song for easier singing, or transpose the keyboard without changing your fingering.

### 9 [DISPLAY CONTRAST] knob

Adjusts the brightness of the display.



**10 [DEMO] button**

Plays the demo song (p. 18).

**11 [MENU] button**

Lets you make various settings for the VIMA (p. 55).

**12 Display**

Here you can select songs and make a variety of settings. The display also shows the tempo and the name of the selected song.

**13 SONG**

Here you can select songs (p. 19, p. 23, p. 27, p. 31). You can also register a favorite or frequently played song (p. 30), or remove a song from the favorites list (p. 32).

**14 PLAYER**

Here you can play back the VIMA's internal songs, songs from a CD-ROM, or songs you've saved in Favorites (p. 19, p. 30). You can also sound a "count" to help you start singing at the correct timing (p. 37).

**15 INSTRUMENT**

Here you can select the sound you'll hear when you play the keyboard (p. 33).

**16 CD drive**

This drive lets you play CD-ROMs made for the VIMA (VIMA TUNES), as well as commercially available music CDs and CD-ROM discs containing SMF music data (p. 22, p. 26).

**17 VOCAL jacks**

Here you can connect microphones. The VIMA lets you use two mics simultaneously, so two people can sing together (p. 45).

## Rear Panel

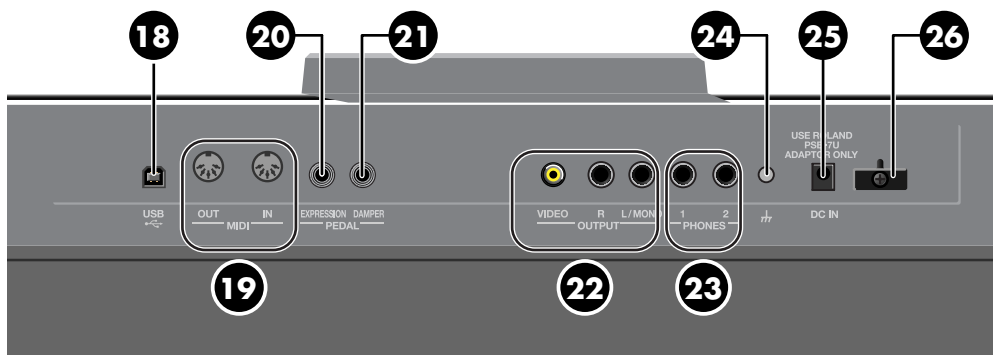

### 18 USB connector

You can connect this to your computer for transferring performance data (p. 54).

### 19 MIDI IN/OUT connectors

You can connect these to external MIDI devices to transfer performance data (p. 53).

This lets you control an external device from the VIMA, or send data to an external sequencer for storage.

### 20 EXPRESSION PEDAL jack

You can connect a separately available expression pedal (EV-5) to this jack and use it to add expression to the sound (p. 39).

### 21 DAMPER PEDAL jack

You can connect a separately sold damper pedal (such as the DP Series), and press it to sustain the notes you play (p. 40).

### 22 VIDEO OUTPUT/AUDIO OUTPUT L/R jacks

Here you can connect a television to view video (p. 52), or connect external speakers to reproduce the sounds of the VIMA (p. 50).

### 23 PHONES jacks

Here you can connect headphones. The VIMA lets you use two sets of headphones simultaneously (p. 16).

\* The volume may be reduced if you use two sets of headphones simultaneously.

### 24 Ground terminal

Depending on the circumstances of a particular setup, you may experience a discomforting sensation, or perceive that the surface feels gritty to the touch when you touch this device, microphones connected to it, or the metal portions of other objects. This is due to an infinitesimal electrical charge, which is absolutely harmless. However, if you are concerned about this, connect the ground terminal with an external ground. When the unit is grounded, a slight hum may occur, depending on the particulars of your installation. If you are unsure of the connection method, contact the nearest Roland Service Center, or an authorized Roland distributor, as listed on the "Information" page.

Unsuitable places for connection

- Water pipes (may result in shock or electrocution)
- Gas pipes (may result in fire or explosion)
- Telephone-line ground or lightning rod (may be dangerous in the event of lightning)

### 25 DC IN jack

Connect the included AC adaptor here (p. 14).

### 26 Cord hook

Use this to fasten the AC adaptor cord (p. 14).

## Main screen



### 1 SONG/LYRIC

The name of the currently selected song is shown here in large characters.

### 2 SONG LOCATION

Here you can select the location in which the desired song is saved (the "song location").

- PRESETS (internal songs)
- CD-ROM
- CD (music CD)
- FAVORITES

### 3 KEY

This indicates the key control setting.  
When you change the key, this will affect the key of both the keyboard and the song.

### 4 TEMPO

This indicates the tempo.

# Before you play

## Getting ready to play

### Connecting the power cord

1. Make sure that the [Power On] switch located at the left side of the keyboard is off (in the upward position).
2. Connect the AC adaptor to the VIMA, and plug the power cord into an AC outlet.  
You must use the power cord included with the VIMA.

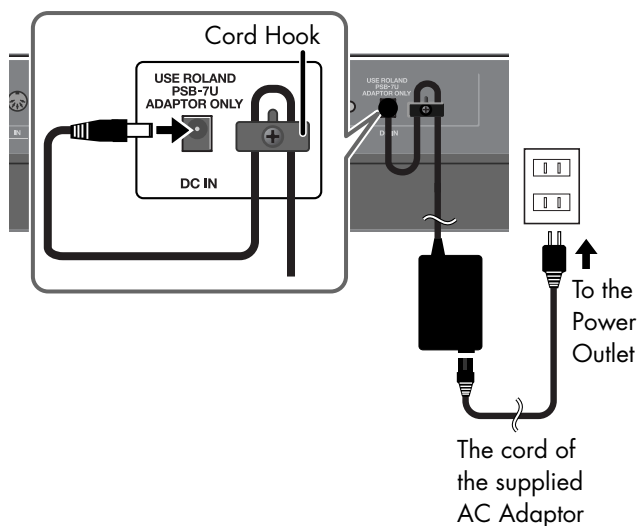

- \* To prevent the inadvertent disruption of power to your unit (should the plug be pulled out accidentally), and to avoid applying undue stress to the DC IN jack, anchor the power cord using the cord hook, as shown in the illustration.

### Turning the power on/off

- NOTE** Once you've got everything connected properly, you can turn on the power using the following procedure. If you fail to perform these steps in the correct order, you risk causing a malfunction or damaging your speakers.

#### Turning the power on

1. Turn the [VOLUME] knob all the way toward the left to minimize the volume.



2. Press the [Power On] switch.

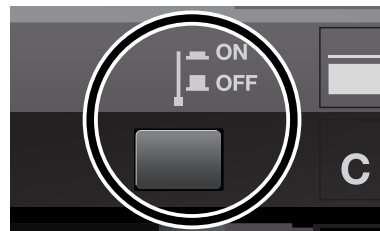

- NOTE** Due to a circuitry protection feature, this unit requires a few moments after power is turned on before it is ready for normal operation.

3. Use the [VOLUME] knob to adjust the volume (p. 15).

#### Turning the power off

1. Turn the [VOLUME] knob all the way toward the left to minimize the volume.



2. Press the [Power On] switch.

The screen goes blank and the power is turned off.

## Adjusting the volume

Here's how to adjust the volume of your keyboard playing or the playback volume of an internal song or CD song.

If headphones are connected, use the [VOLUME] knob to adjust the headphone volume.

### 1. Turn the [VOLUME] knob to adjust the overall volume.

Adjust the volume while you play the keyboard to produce sound.



→ The microphone volume is adjusted with the VOCAL [LEVEL] knob (p. 46).

## Attaching the music rest

Here's how to attach the included music rest.

### 1. Insert the included music rest into the VIMA as shown in the illustration.

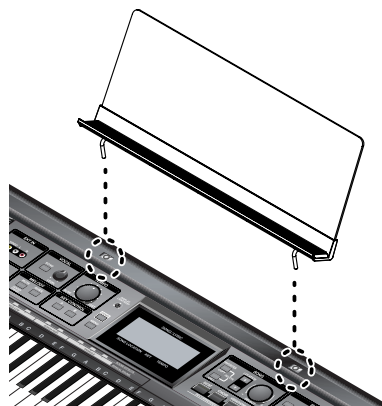

When attaching the music rest, you must use your hand to support it firmly so that it does not fall. Be careful not to pinch your hand.

**NOTE** Don't apply excessive force to the installed music rest.

## Listening through headphones

Since the VIMA has two headphone jacks, two people can use headphones simultaneously. You can also use headphones to enjoy the VIMA without disturbing those around you, such as at night.

If you're using only one set of headphones, you may connect them to either of the two headphone jacks.

\* The volume may be reduced if you use two sets of headphones simultaneously.



**1. Plug the headphones into the PHONES jack located at the VIMA's rear panel.**

If headphones are connected, no sound will be output from the VIMA's speakers.

**2. Use the VIMA's [VOLUME] knob (p. 15) to adjust the headphone volume.**

### Caution when using headphones

- To prevent damage to the cord's internal conductors, avoid rough handling. When using headphones, mainly try to handle either the plug or the headset.
- Your headphones may be damaged if the volume of a device is already turned up when you plug them in. Minimize the volume before you plug in the headphones.
- Excessive input will not only damage your hearing, but may also strain the headphones. Please enjoy music at an appropriate volume.
- Use headphones that have a stereo 1/4" phone plug.

## Adjusting the brightness of the display

You can adjust the brightness of the VIMA's display.

**1. To adjust the brightness, turn the [DISPLAY CONTRAST] knob located at the left of the VIMA's display.**

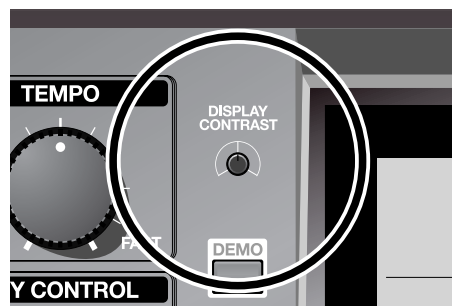

### Cautions regarding the LCD display

- You may notice vertical stripes in the screen; these artifacts are due to the way in which a liquid crystal display is constructed, and do not indicate a malfunction. By using the [DISPLAY CONTRAST] knob to adjust the brightness, you can minimize the visibility of these artifacts.
- The brightness may be affected by the temperature.



# Listening on the VIMA

## Songs you can play using the VIMA

You can listen to the internal songs, songs from the included CD-ROM, or commercially available music data.

Use the [LOCATION] buttons to select the location that contains the song you want to hear.

For details on how to play back these songs, refer to the explanations below.

What you can play	Explanation
Demo songs	You can play back a demo song that let's you experience the VIMA's beautiful sounds.
Presets	The VIMA has 34 built-in songs. You can also view the lyrics in the VIMA's screen while the song plays.
Songs stored in "FAVORITES"	You can store internal songs or songs from a CD-ROM in "FAVORITES" and listen to them.
CD-ROM included with the VIMA	The CD-ROM included with the VIMA contains 12 songs. You can also view the lyrics in the VIMA's screen while the song plays.
CD-ROMs made for the VIMA	You can play back commercially available CD-ROMs made for the VIMA (VIMA TUNES). You can also view the lyrics in the VIMA's screen while the song plays.  * This instrument (RK-100) is not able to play back VIMA TUNES images.
Music CD	You can play back commercially available music CDs.

### What is Location?

On the VIMA, "Location" refers to a place where songs can be found, such as "PRESETS (internal songs)," "FAVORITES," or "CD-ROM."

## Listening to the demo song

Here's how you can play back a demo song that lets you experience the VIMA's beautiful sounds.

- 1. Use the [VOLUME] knob to adjust the volume (p. 15).**
- 2. Press the [DEMO] button so it's lit.**

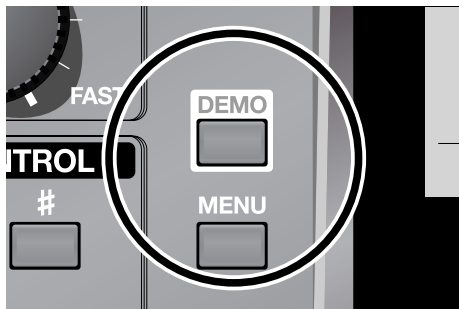

The demo song begins playing.

When playback reaches the end of the song, it will resume again from the beginning.

- 3. Press the [DEMO] button once again to stop playback.**

## Listening to internal songs

The VIMA contains 34 internal songs.  
Here's how to select and play back one of these songs.

### Selecting a song

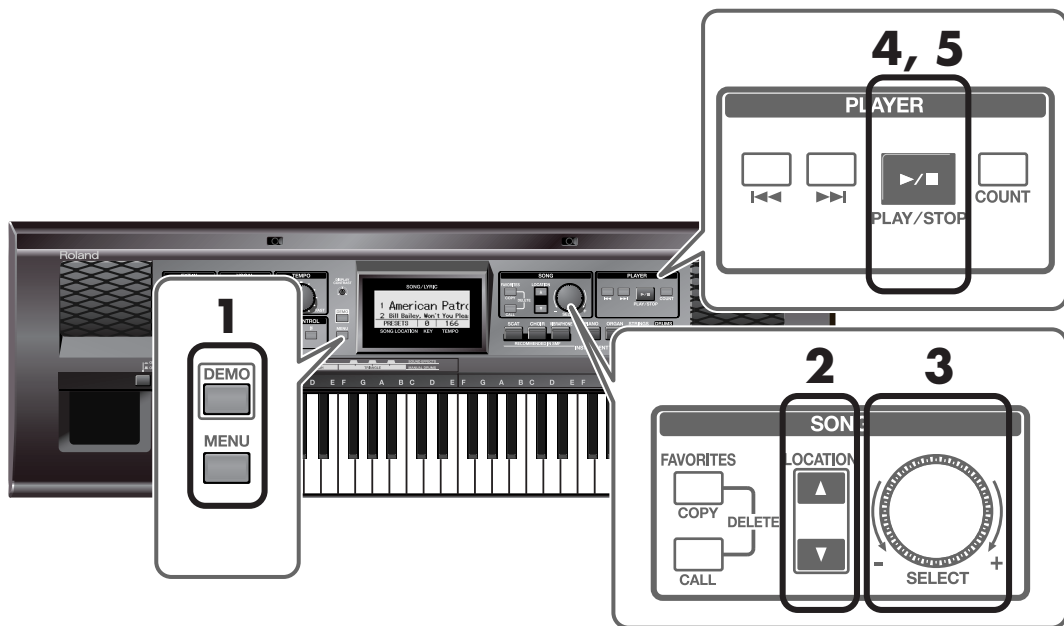

- 1. Make sure that the [DEMO] button and [MENU] button are unlit.**  
If either is lit, press the button to turn it off.
- 2. Use the [LOCATION] buttons to select <PRESETS>.**



The VIMA's screen will show a list of the internal songs.

- 3. Turn the SONG [SELECT] knob to select the song that you want to play.**

## Playing the song

---

### 4. Press the [PLAY/STOP] button.

The selected song will play.

#### Panel [ ⏮ ] button and [ ⏭ ] button

Depending on whether the song is stopped or playing, the [ ⏮ ] button and [ ⏭ ] button will do the following.

#### When the song is stopped

[ ⏮ ] button Returns to the beginning of the song.  
Pressing this button at the beginning of a song will select the preceding song.

[ ⏭ ] button Selects the next song.

#### When the song is playing

[ ⏮ ] button Returns to the beginning of the playing song.  
Pressing this button at the beginning of a song will select the preceding song.

Hold down this button to rewind the song.

[ ⏭ ] button Selects the next song.

Hold down this button to fast-forward the song.

## Stopping the song

---

### 5. Press the [PLAY/STOP] button once again.

- You can also play back commercially available music CDs.
- If there's a song that you're practicing or that you particularly like, you can save it in "Favorites" for easy access.
  - "Internal Song List" (p. 69)
  - "Listening to songs from a CD-ROM" (p. 22)
  - "Listening to songs from a music CD" (p. 26)
  - "Listening to songs saved in "Favorites"" (p. 30)

## Changing the tempo of a song

Here's how to change the tempo of a song.

If a song is too fast for you to play or sing along comfortably, you can slow it down to a more comfortable tempo.

Changing the tempo will not affect the pitch. You can also change the tempo even while the song is playing.

### 1. Turn the [TEMPO] knob to adjust the tempo.

Turning the [TEMPO] knob toward the left ("SLOW") will slow down the tempo, and turning it toward the right ("FAST") will speed up the tempo.

You can adjust the tempo in a range between half and double the original tempo (however, limited to a range between 20 and 250 quarter notes per minute).

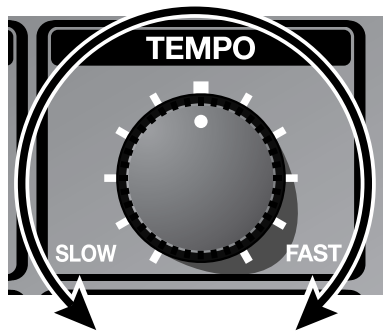

## Listening to songs from a CD-ROM

You can play back songs from a CD-ROM containing SMF music data, the CD-ROM included with the VIMA, or a CD-ROM made for the VIMA (VIMA TUNES).

### Inserting the CD-ROM into the CD drive

---

1. Press the [CD EJECT] button to open the disc tray.

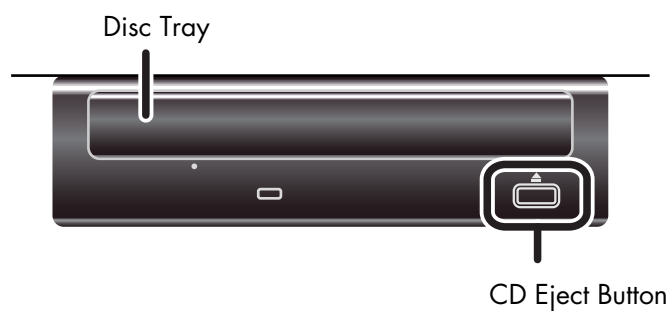

2. Place the CD-ROM on the disc tray.
3. Press the [CD EJECT] button to close the disc tray.

**NOTE** After you close the disc tray, a certain amount of time will be required for the CD-ROM to load.

**NOTE** The display backlight may flicker when the CD drive motor operates.

## Selecting a song from CD-ROM

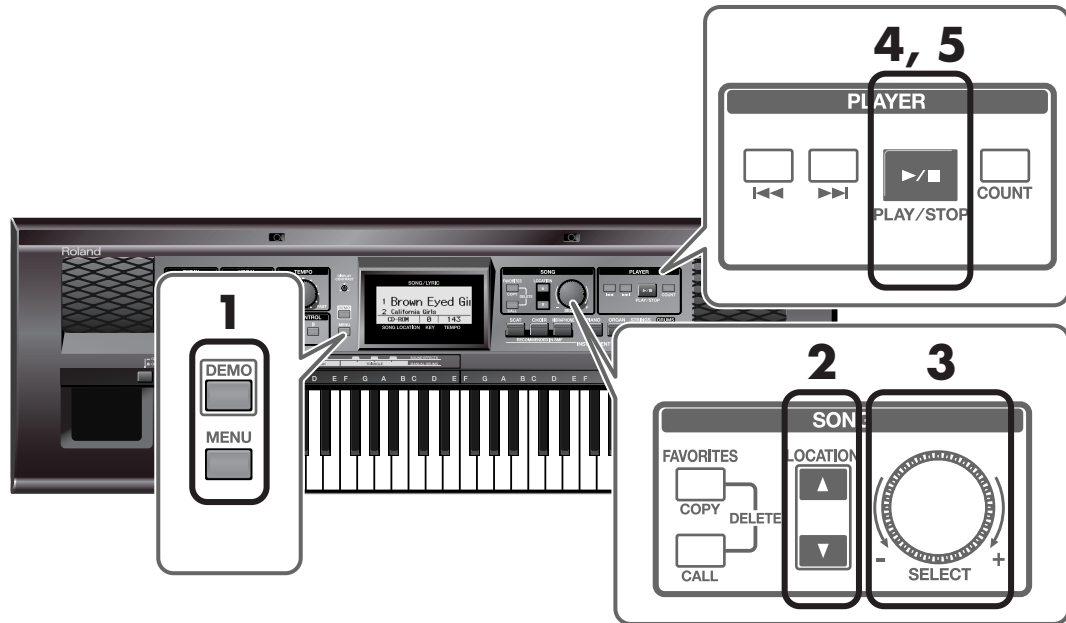

1. Make sure that the [DEMO] button and [MENU] button are unlit.

If either is lit, press the button to turn it off.

2. Use the [LOCATION] buttons to select <CD-ROM>.



The VIMA's screen will show a list of the songs on the CD-ROM.

3. Turn the SONG [SELECT] knob to select the song that you want to play.

## Playing a song from a CD-ROM

---

### 4. Press the [PLAY/STOP] button.

The selected song will play.

#### Panel [ ⏮ ] button and [ ⏭ ] button

Depending on whether the song is stopped or playing, the [ ⏮ ] button and [ ⏭ ] button will do the following.

#### When the song is stopped

[ ⏮ ] button Returns to the beginning of the song.  
Pressing this button at the beginning of a song will select the preceding song.

[ ⏭ ] button Selects the next song.

#### When the song is playing

[ ⏮ ] button Returns to the beginning of the playing song.  
Pressing this button at the beginning of a song will select the preceding song.  
Hold down this button to rewind the song.  
By pressing the [ ⏭ ] button while rewinding, you can rewind more rapidly.

[ ⏭ ] button Selects the next song.  
Hold down this button to fast-forward the song.  
By pressing the [ ⏮ ] button while fast-forwarding, you can fast-forward more rapidly.

## Stopping the song

---

### 5. Press the [PLAY/STOP] button once again.

- You can also play the VIMA's internal songs or commercially available music CDs.
- If there's a song that you're practicing or that you particularly like, you can save it in "Favorites" for easy access.
  - "Listening to internal songs" (p. 19)
  - "Listening to songs from a music CD" (p. 26)
  - "Listening to songs saved in "Favorites"" (p. 30)



## Removing the CD-ROM

---

1. Press the [CD EJECT] button to open the disc tray.
2. Remove the CD-ROM from the disc tray.

### If the disc tray does not open

If, due to a power failure or other problem, the disc tray fails to open when you press the [CD EJECT] button, switch off the RK-100's power, then insert a straightened paper clip or similar object into the emergency eject hole to forcibly open the disc tray.



Emergency Eject Hole

**NOTE** The emergency eject hole must be used only when the VIMA's power is switched OFF. Using it while the power is on may damage the disc or cause serious problems.

## Listening to songs from a music CD

You can also play back commercially available music CDs.

### Inserting the music CD into the CD drive

---

1. Press the [CD EJECT] button to open the disc tray.

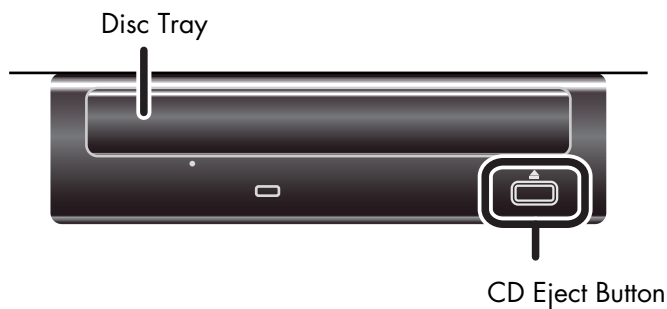

2. Place the CD on the disc tray.
3. Press the [CD EJECT] button to close the disc tray.

**NOTE** After you close the disc tray, a certain amount of time will be required for the music CD to load.

**NOTE** The display backlight may flicker when the CD drive motor operates.

## Selecting a song from a music CD

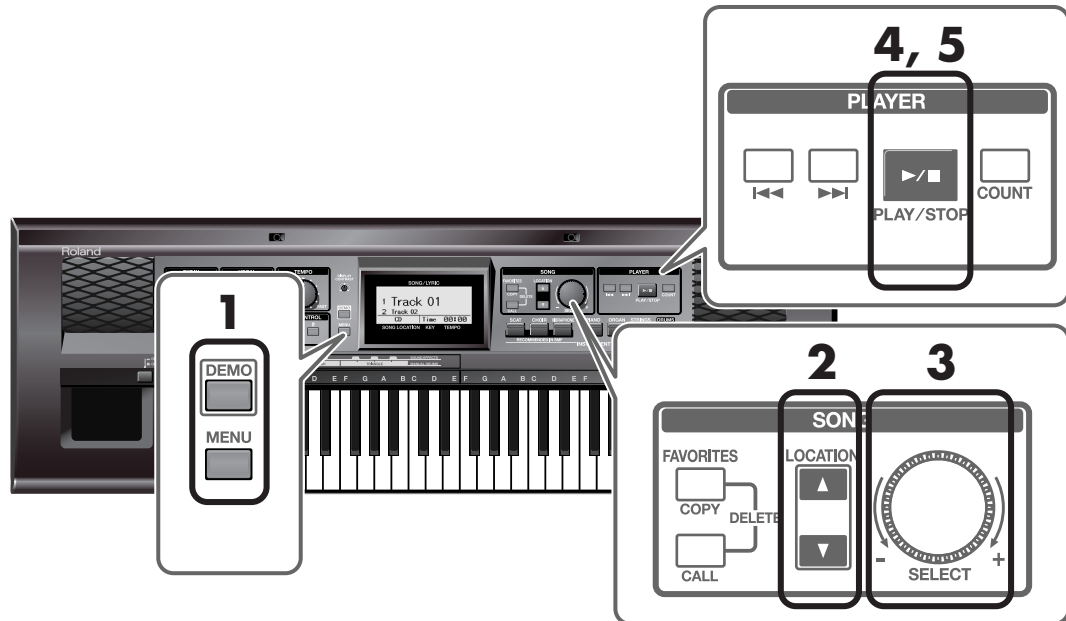

1. Make sure that the [DEMO] button and [MENU] button are unlit.

If either is lit, press the button to turn it off.

2. Use the [LOCATION] buttons to select <CD>.

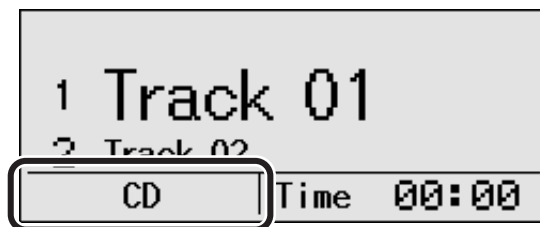

The VIMA's display will indicate the track numbers of the songs on the music CD.

3. Turn the SONG [SELECT] knob to select the song that you want to play.

## Playing a song from a music CD

---

### 4. Press the [PLAY/STOP] button.

The selected song will play.

#### Panel [ ⏮ ] button and [ ⏭ ] button

Depending on whether the song is stopped or playing, the [ ⏮ ] button and [ ⏭ ] button will do the following.

#### When the song is stopped

[ ⏮ ] button Returns to the beginning of the song.  
Pressing this button at the beginning of a song will select the preceding song.

[ ⏭ ] button Selects the next song.

#### When the song is playing

[ ⏮ ] button Returns to the beginning of the playing song.  
Pressing this button at the beginning of a song will select the preceding song.  
Hold down this button to rewind the song.  
By pressing the [ ⏭ ] button while rewinding, you can rewind more rapidly.

[ ⏭ ] button Selects the next song.  
Hold down this button to fast-forward the song.  
By pressing the [ ⏮ ] button while fast-forwarding, you can fast-forward more rapidly.

## Stopping the song

---

### 5. Press the [PLAY/STOP] button once again.



Songs from a music CD can't be saved in "Favorites."

## Removing the CD

---

1. Press the [CD EJECT] button to open the disc tray.
2. Remove the CD from the disc tray.

### If the disc tray does not open

If, due to a power failure or other problem, the disc tray fails to open when you press the [CD EJECT] button, switch off the RK-100's power, then insert a straightened paper clip or similar object into the emergency eject hole to forcibly open the disc tray.



Emergency Eject Hole

**NOTE** The emergency eject hole must be used only when the VIMA's power is switched OFF. Using it while the power is on may damage the disc or cause serious problems.

## Listening to songs saved in "Favorites"

If there's a song that you particularly like or listen to often, you can register it in "Favorites" for easy access.

### What is "Favorites"?

This is a storage area in which you can save songs from a CD-ROM or from presets. If you've saved a song in "Favorites," you can simply choose "Favorites" and select that song at any time.

Since songs saved in "Favorites" will not disappear even if the power is turned off, you will find it convenient to save songs that you want to hear frequently.

## Saving a song in "Favorites" (Copy)

### 1. Get ready to save the song.

If you're going to save a song from CD-ROM, insert the CD-ROM into the CD drive.



Songs from a music CD can't be saved in "Favorites."

### 2. Select the song that you want to save in "Favorites."

### 3. Press the [COPY] button.

The currently selected song will be saved in "Favorites."

A "\*" symbol is shown for the names of songs you've saved.



**NOTE** Don't remove the CD-ROM until the song has been saved. Also, you must never turn off the power until the song has been saved. Doing so will damage the VIMA's internal memory, rendering it unusable.

**NOTE** You can save up to 99 songs in "Favorites." However, if the remaining amount of space is insufficient, an error message (p. 63) will appear and you won't be able to save another song even though fewer than 99 songs have been saved. In this case, if you delete some of the songs in "Favorites" you'll be able to save more songs (p. 32).

**NOTE** Approximately one minute of processing time may be required when you save a song in "Favorites."

**MEMO** If you want to erase all of the content saved in "Favorites" and restore the VIMA to its factory-set condition, refer to "Restoring the factory-set condition (Factory Reset)" (p. 58).

## Playing a song from "Favorites"

### Selecting a song

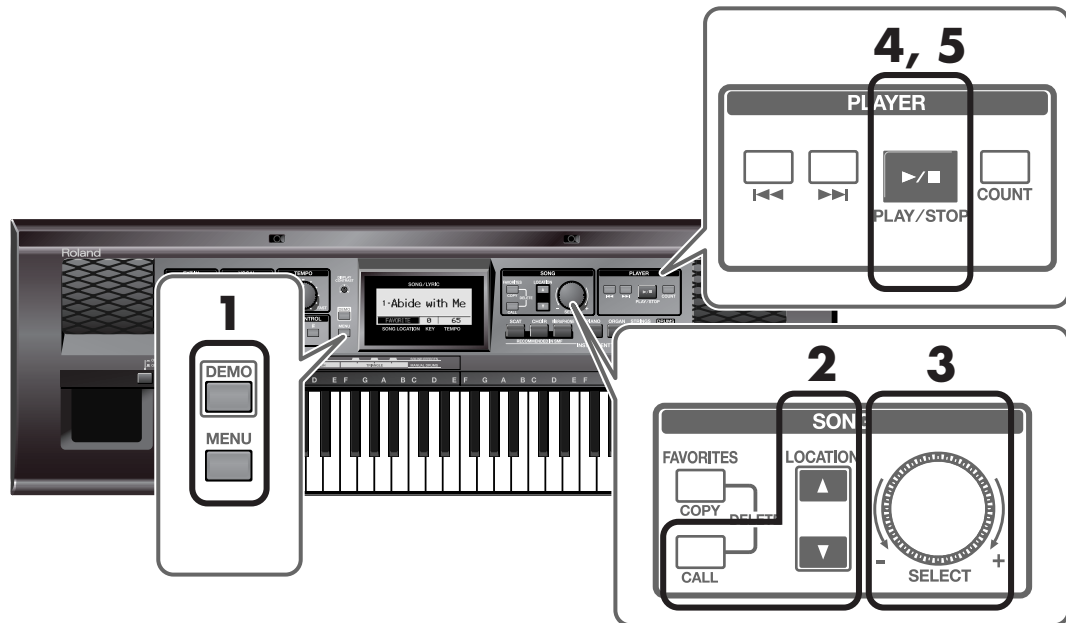

- 1.** Make sure that the [DEMO] button and [MENU] button are unlit.  
If either is lit, press the button to turn it off.
- 2.** Use the [LOCATION] buttons to select <FAVORITES>.  
Alternatively, press the [CALL] button.



The VIMA's screen will show a list of the songs saved in "Favorites."

- 3.** Turn the SONG [SELECT] knob to select the song that you want to play.

**NOTE** If no songs have been saved in "Favorites," no song list will appear when you choose "Favorites" as the song location.

## Playing a song

---

### **4. Press the [PLAY/STOP] button.**

The selected song will play.

## Stopping the song

---

### **5. Press the [PLAY/STOP] button once again.**

## Deleting a song from "Favorites"

- 1. Select the song that you want to delete (p. 31).**
- 2. Simultaneously press the [COPY] button and [CALL] button.**

**NOTE** Never turn off the power while the screen indicates "Now processing..."



# Playing the VIMA

## Selecting the sound played from the keyboard

The VIMA has seven INSTRUMENT buttons. Press one of these buttons to select the sound you'll play from the keyboard.

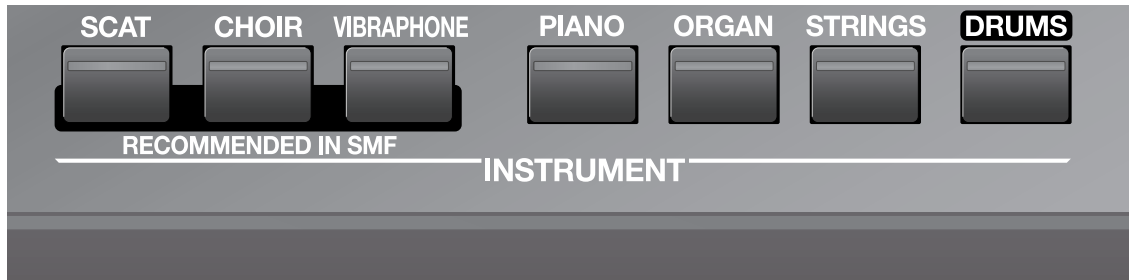

## Affixing the included note name label

If desired, you can affix the included note ID label (two types) or drum sheet (one label) in the locations shown below.

You may find this a helpful way to remember the note names, or useful when playing percussion instrument sounds.



Drum Key-Map Label

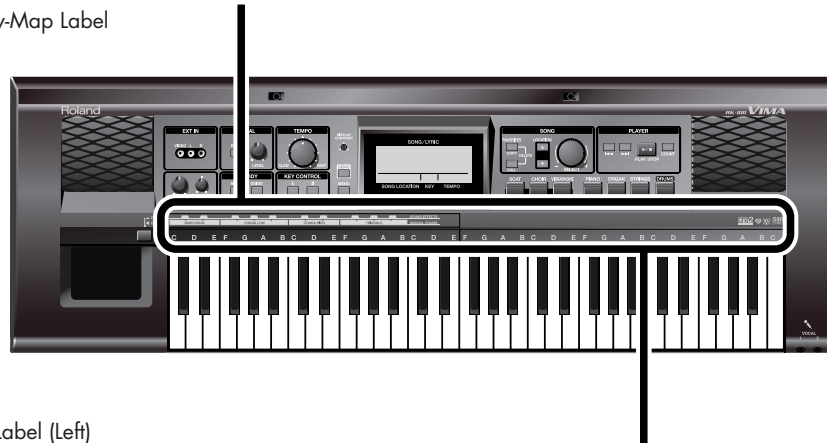

Note ID Label (Left)



Note ID Label (Right)



You can play two different sounds by pressing two INSTRUMENT buttons simultaneously. For example, if you press the [ORGAN] button while holding down the [PIANO] button, a piano sound will play at the right side of the keyboard, while an organ sound will be heard from the left.

## Playing sound effects or percussion instruments from the keyboard

You can play sound effects or percussion instrument sounds from the keyboard.

- 1. Press the [DRUMS] button so it's lit.**
- 2. Play notes in the C2–B3 range on the keyboard.**

The white keys in the C2–B3 range will play drum sounds. The black keys in the C # 2 to B ♭ 3 range will play sound effects.

Keys in the C4–C7 range will play the sound that was selected before the [DRUMS] button was pressed.

For example, if you had pressed the [PIANO] button and were playing the piano sound, and then pressed the [DRUMS] button, the keyboard will play the following sounds.

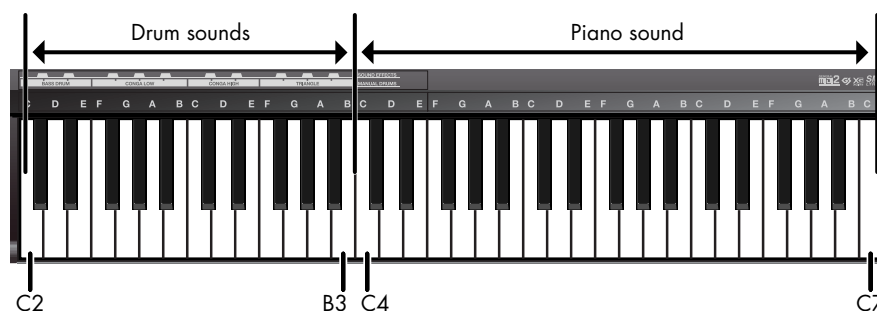

### Muting the percussion instrument sounds

---

- 3. Press the [DRUMS] button to turn it off.**

## Performing with sounds that match the song (Recommended Tone)

If you've selected a preset (internal) song or a song from a CD-ROM made for the VIMA (VIMA TUNES), you can conveniently select "recommended" sounds that are suitable for that song.

### Choosing the Recommended tones

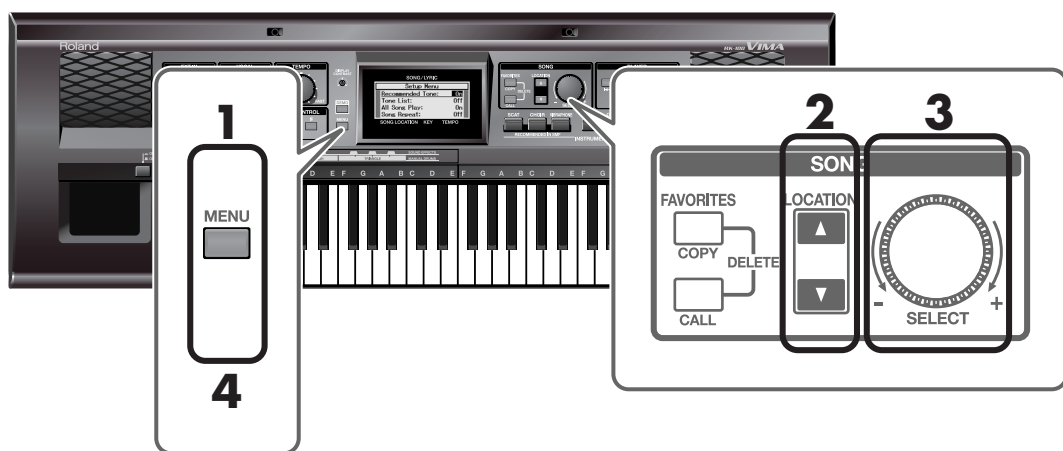

1. Press the [MENU] button so it's lit.  
The Setup Menu screen appears.
2. Use the [LOCATION] buttons to select <Recommended Tone>.
3. Turn the SONG [SELECT] knob to turn the <Recommended Tone> setting <On>.

Setup Menu	
Recommended Tone:	On
Tone List:	Off
All Song Play:	On
Song Repeat:	Off

4. Press the [MENU] button to turn it off.
5. Play along with the song.

When you press the [SCAT] button, [CHOIR] button, or [VIBRAPHONE] button, an instrument suitable for the selected song will automatically assigned to the keyboard.

## Returning to the previous state

.....

- 1. Press the [MENU] button so it's lit.**

The Setup Menu appears.

- 2. Use the [LOCATION] buttons to select <Recommended Tone>.**

- 3. Turn the SONG [SELECT] knob to turn the <Recommended Tone> setting <Off>.**

- 4. Press the [MENU] button to turn it off.**

You're returned to the previous screen.

In this state, pressing the [SCAT] button, [CHOIR] button, or [VIBRAPHONE] button will select the corresponding instrument.

## Sounding a count to keep your timing accurate

You can make the VIMA sound a count at the end of the song's introduction (i.e., before you begin playing). If you listen to this count, it will be easier for you to begin playing or singing along with the song at the correct timing.

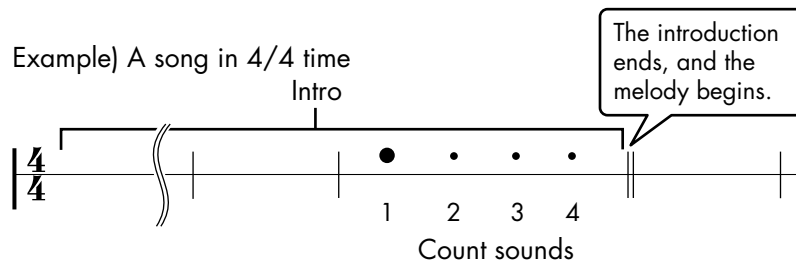

1. Press the [COUNT] button so it's lit.

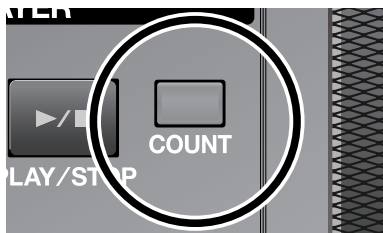

This enables the count to sound.

A one-measure count sounds before the melody begins.

## Stopping the count from sounding

1. Press the [COUNT] button to turn it off.



The count will not sound if you're playing a song that does not contain count data (such as a music CD).

## Adjusting the volume balance between the song and keyboard

You can adjust the volume balance between the song that's playing and your performance on the keyboard.

If you're performing along with the playback of a song, lowering the volume of the song will make it easier for you to hear your own keyboard performance.

1. Turn the [BALANCE] knob to adjust the volume balance.

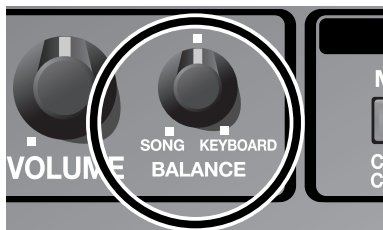

Operation	Explanation
Turning the [BALANCE] knob toward "SONG"	Decreases the volume of the keyboard.
Turning the [BALANCE] knob toward "KEYBOARD"	Decreases the volume of the song.

## Using an expression pedal to make your performance expressive

You can connect an expression pedal (sold separately) and use it to adjust the volume. By adjusting the volume while you play, you can add dynamic expression to your performance.

The volume increases as you push forward on the pedal, and decreases as you release the pedal.

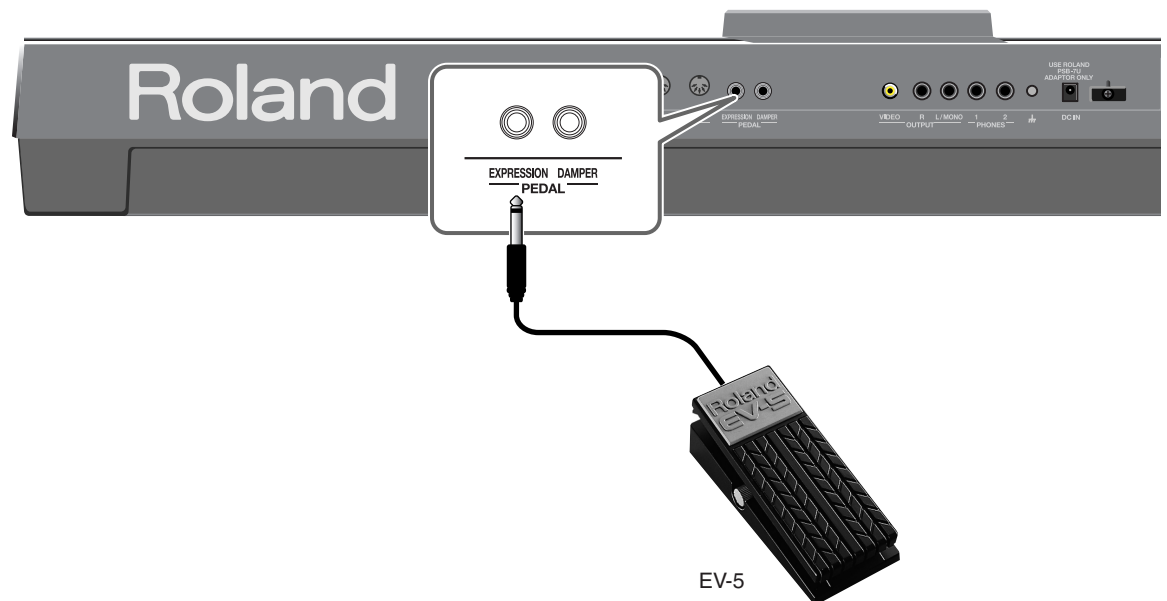

1. **Connect the expression pedal to the EXPRESSION PEDAL jack located on the rear panel of the VIMA.**

**NOTE** You must use only the specified expression pedal (EV-5; sold separately). Connecting a product made by another manufacturer may cause the VIMA to malfunction.

2. **Operate the expression pedal while you play the keyboard.**

The volume of notes you play on the keyboard will change, allowing you to apply expression to your performance.

**NOTE** The drum volume will not change.

## Using a damper pedal to play smoothly

You can connect a damper pedal (sold separately) to help you play notes smoothly. As long as you hold down the damper pedal, notes will be sustained even after you take your finger off the key, causing the sound to decay slowly.

On acoustic pianos, pressing the damper pedal will cause sympathetic vibration to occur in strings other than the strings of the notes you actually played, producing a rich resonance. The VIMA simulates these sympathetic vibrations (damper resonance).

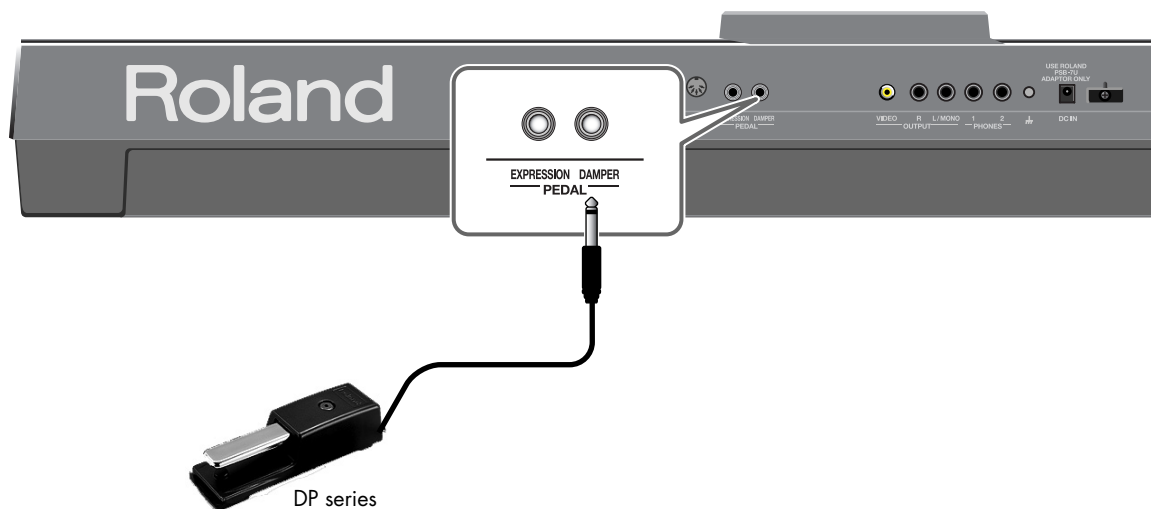

- 1. Connect the damper pedal to the DAMPER PEDAL jack located on the rear panel of the VIMA.**

**NOTE** You must use only the specified damper pedal (DP series; sold separately). Connecting a product made by another manufacturer may cause the VIMA to malfunction.

- 2. Press the damper pedal while you play the keyboard.**

The notes you play on the keyboard will be sustained, producing a smoother performance.



## Muting the melody from a song (Melody Mute)

You can play back a preset (internal) song or a song from a CD-ROM made for the VIMA (VIMA TUNES) with the melody portion muted. This is called the “Melody Mute” function. While listening to the song, you can play the melody yourself.

**MEMO** There’s also a “Melody Guide” function (p. 42), which lets you decrease the volume of the melody so that you can practice playing the melody along with the song, but still hear the melody until you’ve learned it.

### 1. Prepare to play back the desired song.

If you want to play back a song from a CD-ROM, insert the CD-ROM into the CD drive (p. 22).

### 2. Select the song that you want to play (p. 19, p. 22).

### 3. Press the [MUTE/CENTER CANCEL] button so it’s lit.

The Melody Mute function is turned on.

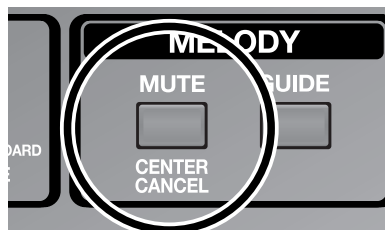

### 4. Press the [PLAY/STOP] button to play back the song.

When the song plays, the sound of the melody will be temporarily muted. Play the melody yourself while listening to the other parts of the song.

**NOTE** If the melody is not muted when you press the MELODY [MUTE/CENTER CANCEL] button, change the melody channel setting as it will depend on the song.  
→ “Changing the melody channel (Melody Channel)” (p. 57)

## To cancel the Melody Mute function

### 1. Press the [MUTE/CENTER CANCEL] button to turn it off.

The Melody Mute function is turned off.

When you play back the song, the melody will return to its original volume.

## Playing while you listen to the song melody (Melody Guide)

You can play back a preset (internal) song or a song from a CD-ROM made for the VIMA (VIMA TUNES) with the melody at a lower volume. This is called the “Melody Guide” function. Until you’ve learned the melody, you can play back the song with the melody at a lower volume, and practice your performance.

Once you’ve learned the melody, use the Melody Mute function (p. 41) to perform with the melody completely muted.

### 1. Prepare to play back the desired song.

If you want to play back a song from a CD-ROM, insert the CD-ROM into the CD drive (p. 22).

### 2. Select the song that you want to play (p. 19, p. 22).

### 3. Press the MELODY [GUIDE] button so it’s lit.

The Melody Guide function is turned on.

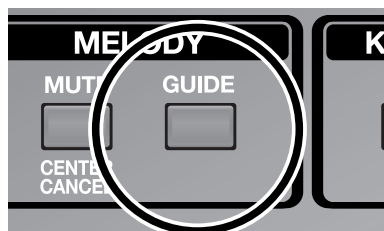

### 4. Press the [PLAY/STOP] button to play back the song.

When the song plays back, the volume of the melody will be temporarily lowered.

While listening to the song, play along with the melody. The melody will be heard at a lower volume, so you can use it as a guide.

**NOTE** If the volume of the melody does not decrease when you press the MELODY [GUIDE] button, change the melody channel setting as it will depend on the song.  
→ “Changing the melody channel (Melody Channel)” (p. 57)

## To cancel the Melody Guide function

---

### 1. Press the MELODY [GUIDE] button to turn it off.

The Melody Guide function is turned off.

When you play back the song, the melody will return to its original volume.

## Performing with your favorite sounds (Tone List)

The VIMA contains the sounds of numerous instruments in addition to the seven sounds accessible through the INSTRUMENT buttons. This lets you enjoy performing with sounds that are appropriate with a wide range of musical styles.

### Selecting instruments

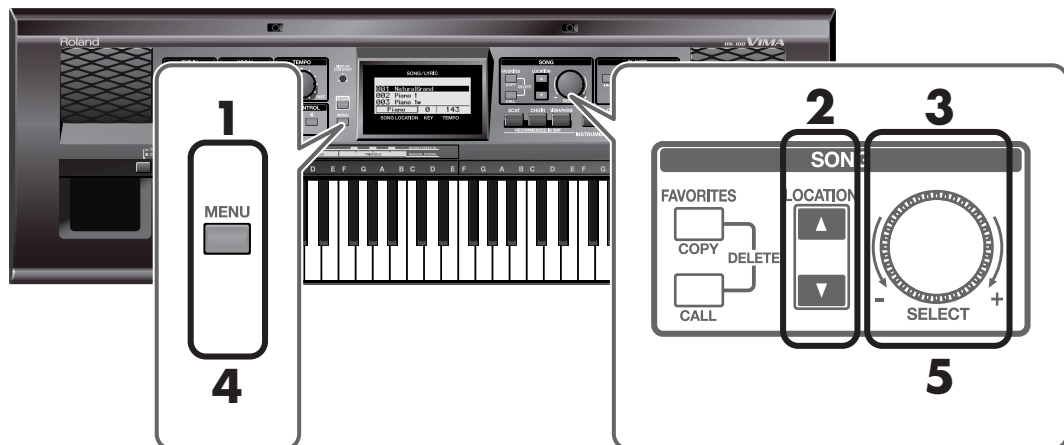

1. Press the [MENU] button so it's lit.  
The Setup Menu screen appears.
2. Use the [LOCATION] buttons to select <Tone List>.
3. Turn the SONG [SELECT] knob to turn the <Tone List> setting <On>.

Setup Menu	
Recommended Tone:	Off
Tone List:	<b>On</b>
All Song Play:	On
Song Repeat:	Off

4. Press the [MENU] button to turn it off.  
The Tone List screen appears.

001	NaturalGrand
002	Piano 1
003	Piano 1w
Piano	0 143

5. Turn the SONG [SELECT] knob to select an instrument.  
By pressing a [LOCATION] button you can choose the first sound in each instrument group.
6. Play the keyboard.  
You'll hear the instrument you selected.

## Returning to the previous state

---

- 1. Press the [MENU] button so it's lit.**

The Setup Menu screen appears.

- 2. Use the [LOCATION] buttons to select <Tone List>.**

- 3. Turn the SONG [SELECT] knob to turn the <Tone List> setting <Off>.**

- 4. Press the [MENU] button to turn it off.**

You're returned to the previous screen.

# Singing along with the VIMA

You can connect a microphone to the microphone jack and use the VIMA for karaoke or for singing along with your own playing. Since the VIMA has two microphone jacks, you can connect two mics simultaneously for a duet.

You can also apply echo to the sound of the microphone for additional enjoyment.

## Connecting a microphone

### 1. Plug the mic(s) into the VOCAL jack(s) located at the right of the VIMA's front panel.

If you're using only one microphone, you may connect it to either of the two VOCAL jacks.



### Cautions when using a microphone

- Be careful of the volume late at night or early in the morning.
- Lower the volume before you connect a microphone to the VIMA. If the volume is raised when you connect a microphone, noise may be output from the speakers.
- Acoustic feedback (a squealing noise) may occur depending on the position of the microphone and speakers. If this happens, take the following steps.
  - Point the microphone in a different direction
  - Move the microphone away from the speakers
  - Lower the volume

## Adjusting the volume of the microphone

You can adjust the volume of the sound from the microphone.

If two mics are connected, this will change the volume of both mics.

### 1. Turn the [VOLUME] knob to adjust the overall volume (p. 15).

If you're singing along with the song, adjust the song volume by turning the [VOLUME] knob while the song plays.

If you're playing the keyboard while you sing, adjust the keyboard volume by turning the [VOLUME] knob while you play the keyboard.

### 2. Turn the panel VOCAL [LEVEL] knob to adjust the microphone volume.

Turning the VOCAL [LEVEL] knob toward the left will lower the microphone volume, and turning it toward the right will raise the microphone volume.

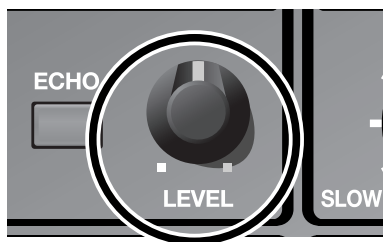

**NOTE** You cannot adjust the volume of the two microphones individually.

**NOTE** When you do not need to use a microphone, rotate the VOCAL [LEVEL] knob all the way to the left. This is to prevent noise from occurring.

## Changing the song to a key that's comfortable for singing (Key Control)

The "Key Control" function lets you play back a song at a different key. This is convenient when you're singing along with the song, since you can shift the playback to a key that's comfortable for the range of your voice.

You can also use this function to transpose the pitch of your playing without changing your fingering on the keyboard. For example, if the song is in a difficult key with numerous sharps (#) or flats (b), you can transpose to a key that's easier for you to play.

### 1. Use the KEY CONTROL [b] [#] buttons to change the key (pitch).

Each time you press a KEY CONTROL [b] [#] button, the key is changed by a semitone. Pressing the [b] button lowers the key, and pressing the [#] button raises the key.

The value you specify is shown in the screen.

You can adjust the value in semitone steps over a range of -6 to +5.

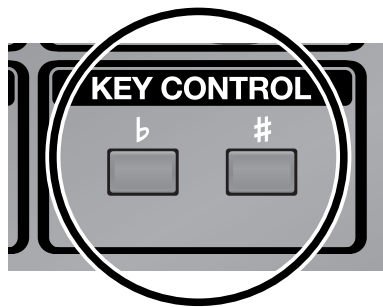

You can return to the original key by pressing the [b] button and [#] button simultaneously.

## Adding echo to vocals

You can add echo to vocals arriving via the microphone. This will make singing more enjoyable.

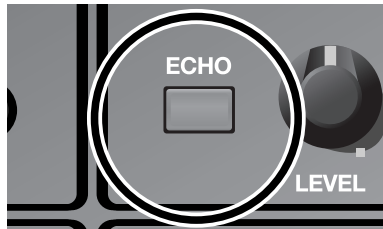

- 1. Press the VOCAL [ECHO] button so it's lit.**
- 2. Sing into the microphone.**

Echo will be applied to the sound from the microphone.

### To turn off the echo

---

- 1. Press the [ECHO] button to turn it off.**



## Enjoying karaoke with a commercially available music CD (Center Cancel)

You can eliminate sounds (such as vocals) localized at the center of a commercially available music CD, and sing the vocal yourself. This is a convenient way to use your favorite music CD to enjoy karaoke or for vocal practice.

1. Insert your CD into the CD tray, and select the song that you want to play (p. 26).

2. Press the [MUTE/CENTER CANCEL] button so it's lit.

The Center Cancel function is active.

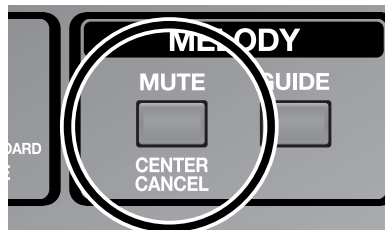

3. Press the [PLAY/STOP] button to play the song.

When the song plays, sounds localized at the center (such as vocals) will be temporarily muted.

Sing along with the song.

**NOTE** For some songs, the vocal sound may not be eliminated completely.

4. Press the [PLAY/STOP] button to stop playback.

### To defeat the Center Cancel function

1. Press the [MUTE/CENTER CANCEL] button to turn it off.

The Center Cancel function is turned off.

When you play back the song, the melody or vocal will be heard at its original volume.

**MEMO** The [MELODY MUTE] button won't function if you're playing a music CD.

# Connecting other equipment

## Connecting audio equipment

By connecting the VIMA to your audio equipment or external speakers, you can play the VIMA's sounds from your stereo system's speakers or from other external speakers, or record your performance on an MD recorder or other recording device.

To make connections, use an audio cable with 1/4" phone plugs.

- \* When connection cables with resistors are used, the volume level of equipment connected to the inputs may be low. If this happens, use connection cables that do not contain resistors.
- \* Before connecting the VIMA to other devices, you must turn down the volume of all devices and turn off their power to prevent malfunctions or speaker damage.

## Playing the VIMA through connected speakers

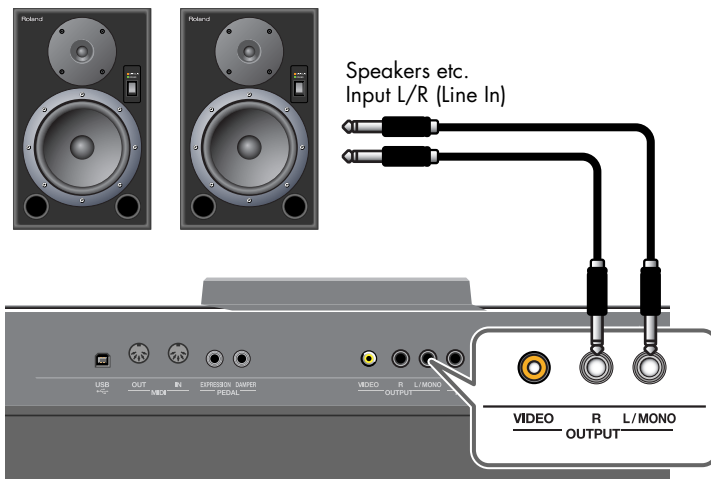

The VIMA's Rear Panel

1. Minimize the volume of the VIMA and of the speakers.
2. Switch off power to the VIMA and the speakers.
3. Make connections using separately available audio cables.
4. Switch on the VIMA's power.
5. Switch on power to the speakers.
6. Adjust the volume of the VIMA and the speakers.

When you play the VIMA's keyboard, you'll hear the sound from the connected speakers.

## Turning the power off

1. Minimize the volume of the VIMA and of the speakers.
2. Switch off power to the speakers.
3. Switch off power to the VIMA.

## Playing the sound of an audio device through the VIMA

Portable audio player etc.

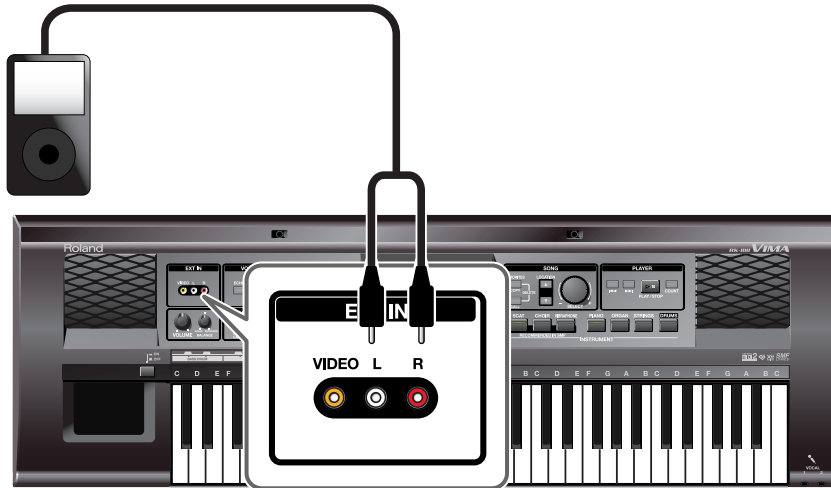

- 1.** Minimize the volume of the VIMA and of the audio device.
- 2.** Switch off power to the VIMA and the audio device.
- 3.** Make connections using separately available audio cables.
- 4.** Switch on power to the audio device.
- 5.** Switch on the VIMA's power.
- 6.** Adjust the volume of the VIMA and the audio device.

The sound of the connected audio device will be heard from the VIMA.

**NOTE** There will be a difference in volume depending on the audio device that's connected.

### Turning the power off

- 1.** Minimize the volume of the VIMA and of the audio device.
- 2.** Switch off power to the VIMA.
- 3.** Switch off power to the connected audio device.

## Connecting a television

You can connect a video device to the VIMA and directly output the image from that video device to a television or other display equipped with a video connector.

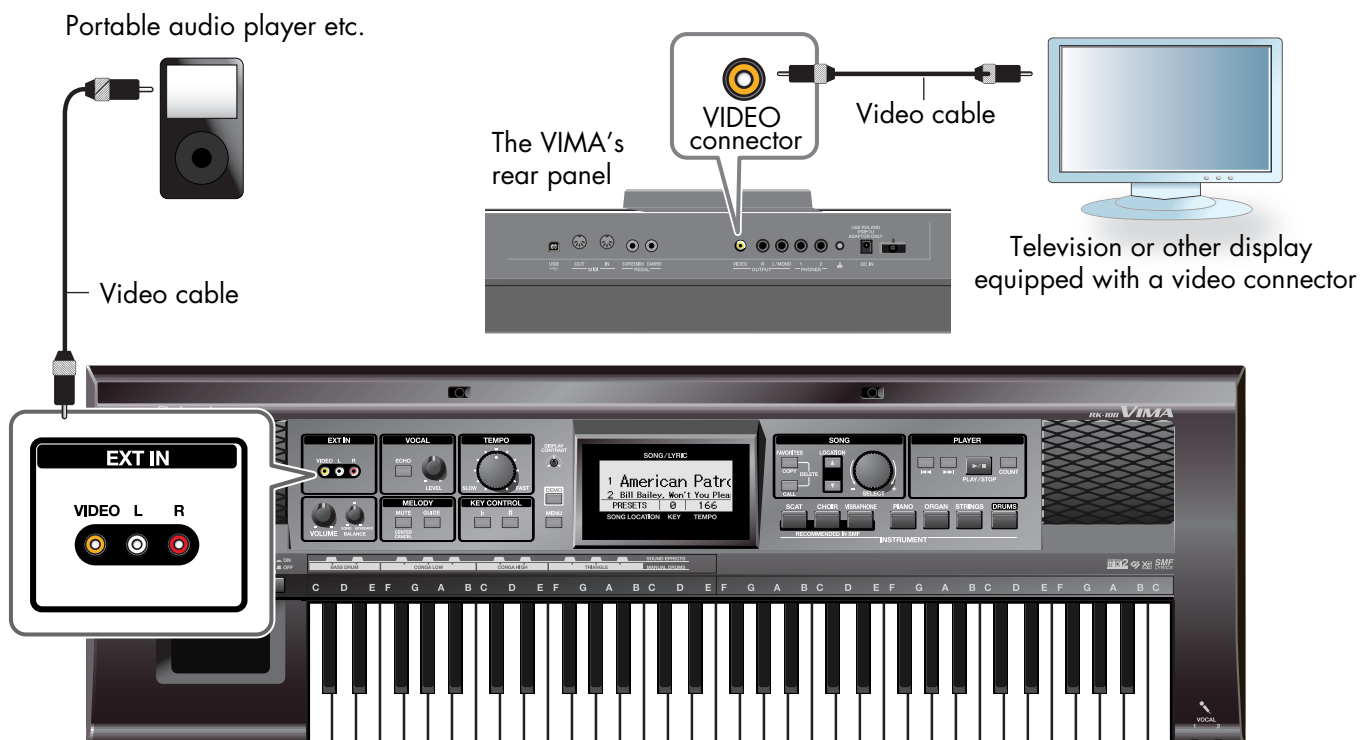

**1. Switch off power to the VIMA, and the television and video device you'll be connecting.**

**2. Connect the video device to the VIMA.**

Use a video cable to connect your video device to the VIMA's VIDEO connector.

**3. Connect the VIMA to your television.**

**4. Switch on the video device's power.**

**5. Switch on power to the VIMA.**

**6. Switch on the television.**

The image from the video input will appear on the television.

**NOTE** The image received at the video input will be output without change from the VIDEO connector. It will not be shown on the VIMA's display.

**NOTE** There will be a difference in volume depending on the video device that's connected.

### Turning the power off

You must observe the following order when you turn off the power.

**1. Switch off the power on the television.**

**2. Minimize the VIMA's volume.**

**3. Switch off the VIMA's power.**

**4. Switch off the video device's power.**

## Connecting MIDI equipment

Performance data can be exchanged between the VIMA and external MIDI equipment, allowing them to control each other. For example, you can play one device from the keyboard of another device, or switch sounds remotely.

### What's MIDI?

"MIDI" stands for "Musical Instrument Digital Interface." It is a universal standard that allows performance data to be exchanged among electronic musical instruments and computers.

The VIMA provides MIDI connectors so that performance data can be transferred between it and other devices. By using these connectors to connect other devices with the VIMA, you can take advantage of a wide range of possibilities.

### Using a MIDI sequencer to play the VIMA

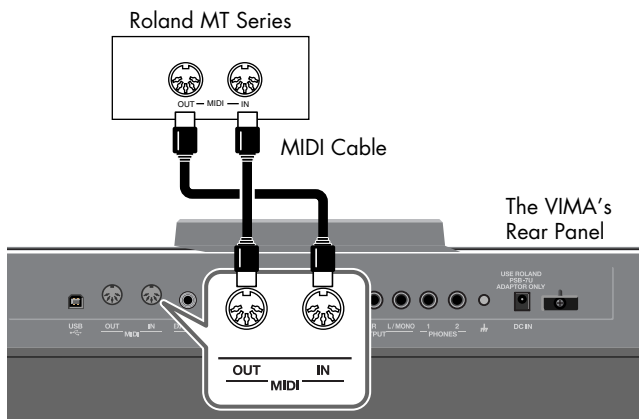

**NOTE** If you connect the VIMA with a MIDI sequencer, turn off the Thru function of the connected MIDI sequencer.

### Playing a MIDI sound module from the VIMA

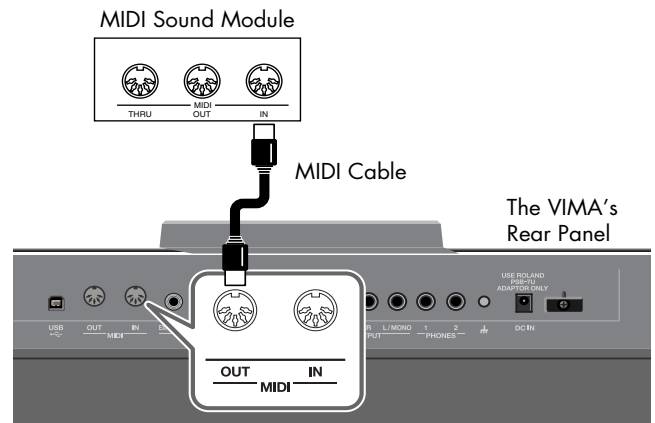

### Making connections

1. Minimize the volume of the VIMA and of the MIDI equipment.
2. Switch off power to the VIMA and the MIDI equipment.
3. As shown in the illustrations, use MIDI cables to connect the VIMA and the MIDI equipment.
4. Switch on power to the VIMA and the connected MIDI equipment.
5. Adjust the volume of the VIMA and the connected MIDI equipment.
6. If necessary, change the MIDI transmit channel.



For details on the MIDI transmit channel, refer to "Changing the MIDI transmit channel (MIDI Tx Channel)" (p. 57).

### Connecting your computer

If you use a USB cable to connect the USB connector located on the VIMA's rear panel to the USB connector of your computer, you'll be able to do the following things.

- Use the VIMA to play SMF data played back by MIDI-compatible software (such as Media Player).
- By transferring MIDI data between the VIMA and your sequencer software, you'll be able to enjoy a wide range of possibilities for music production and editing.

Connect the VIMA to your computer as shown below.

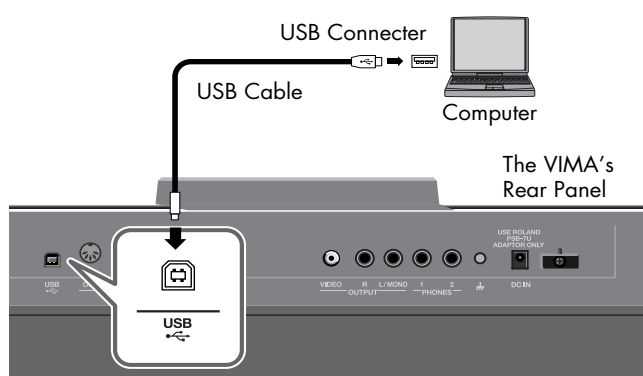

- \* Refer to the Roland website for system requirements. However, please be aware that the VIMA does not support Mac OS 9.  
Roland website: <http://www.roland.com/>
- \* You can't use the MIDI connectors while using the USB connector.

#### Caution

- To avoid the risk of malfunction and/or speaker damage, always make sure to turn the volume all the way down and turn off the power on all equipment before you make any connections.
- Only MIDI data can be transmitted and received via USB.
- A USB cable is not included. If you need to obtain one, ask the dealer where you purchased the VIMA.
- Switch on power to the VIMA before you start up the MIDI application on your computer. Don't turn the VIMA's power on/off while your MIDI application is running.

### If connection to your computer is unsuccessful...

Normally, you don't need to install a driver in order to connect the VIMA to your computer. However, if some problem occurs, or if the performance is poor, using the original driver may solve the problem.

For details on downloading and installing the original driver, refer to the Roland website.

Roland website: <http://www.roland.com/>  
<http://www.Roland-VIMA.com>

Specify the USB driver you want to use, and then install the driver. For details, refer to "USB driver settings (USB Driver)" (p. 58).

## Playing the recommended sounds (Recommended Tone)

If you've selected an internal song or a song from a CD-ROM made for the VIMA (VIMA TUNES), you can conveniently select a "recommended tone" that's suitable for that song.

**1. Press the [MENU] button so it's lit.**

The Setup Menu screen appears.

**2. Use the [LOCATION] buttons to select <Recommended Tone>.**

**3. Turn the SONG [SELECT] knob to turn the <Recommended Tone> setting <On>.**

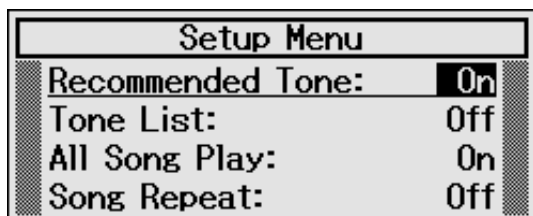

**4. Press the [MENU] button to complete the setting.**

If you want to restore the settings to their original state, turn the above setting <Off>.

## Playing desired sounds (Tone List)

In addition to the seven sounds that can be selected by the INSTRUMENT buttons, the VIMA contains the sounds of numerous other instruments.

To select these instruments, proceed as follows.

**1. Press the [MENU] button so it's lit.**

The Setup Menu screen appears.

**2. Use the [LOCATION] buttons to select <Tone List>.**

**3. Turn the SONG [SELECT] knob to turn the <Tone List> setting <On>.**



**4. Press the [MENU] button to complete the setting.**

The Tone List screen will appear.



group of tones

**5. Turn the SONG [SELECT] knob to select a tone.**

You can use the [LOCATION] buttons to select the first tone in each group of tones.

**6. Play the keyboard.**

If you want to restore the settings to their original state, turn the above setting <Off>.

## Playing all songs consecutively (All Song Play)

Normally, when you select and play a song, playback will stop when you reach the end of the selected song.

However, if you wish, you can make the VIMA play back all the songs that are in the same location.

**1. Press the [MENU] button so it's lit.**

The Setup Menu screen appears.

**2. Use the [LOCATION] buttons to select <All Song Play>.**

**3. Turn the SONG [SELECT] knob to turn the <All Song Play> setting <On>.**

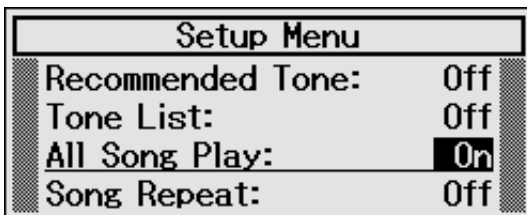

**4. Press the [MENU] button to complete the setting.**

To return to the setting in which each song is played individually, turn the above setting <Off>.

## Playing the same song repeatedly (Song Repeat)

Normally, when you select and play a song, playback will stop when you reach the end of the selected song. However, if you wish, you can make the VIMA play back the same song repeatedly.

**1. Press the [MENU] button so it's lit.**

The Setup Menu screen appears.

**2. Use the [LOCATION] buttons to select <Song Repeat>.**

**3. Turn the SONG [SELECT] knob to turn the <Song Repeat> setting <On>.**



**4. Press the [MENU] button to complete the setting.**

To return to the original state, turn the above setting <Off>.



## Changing the melody channel (Melody Channel)

If the Melody Guide function (p. 42) fails to lower the volume of the song's melody, or if the Melody Mute function (p. 41) fails to mute the melody of the song, you should try changing this setting.

Most commercially available SMF music data consists of sixteen channels (parts).

Each channel contains a separate performance; for example, channel 1 might contain strings and channel 2 bass, with the drums on channel 10. The song data consists of these sixteen channels of performances, played back simultaneously.

Channel 1	Strings
Channel 2	Bass
:	:
Channel 10	Drums
:	:
Channel 16	Guitar

Normally, when you play back Roland SMF music data (p. 70), the melody is assigned to channel 4.

However, some commercially available SMF music data assigns the melody channel to a different channel. In such cases, you'll need to change this setting to the channel that is used by your music data.

### 1. Press the [MENU] button so it's lit.

The Setup Menu screen appears.

### 2. Use the [LOCATION] buttons to select <Melody Channel>.

### 3. Turn the SONG [SELECT] knob to change the <Melody Channel>.

Setup Menu	
Tone List:	Off
All Song Play:	On
Song Repeat:	Off
Melody Channel:	4

#### Settings (Channel)

1-16

### 4. Press the [MENU] button to complete the setting.

## Changing the MIDI transmit channel (MIDI Tx Channel)

This setting specifies the MIDI channel on which the VIMA will transmit.

MIDI uses sixteen "MIDI channels," which are numbered 1 through 16.

By connecting MIDI devices and specifying the appropriate MIDI channel for each device, you can play or select sounds on those devices.

The VIMA will receive all sixteen channels (1-16).



For details on connecting MIDI devices, refer to "Connecting MIDI equipment" (p. 53).

### 1. Press the [MENU] button so it's lit.

The Setup Menu screen appears.

### 2. Use the [LOCATION] buttons to select <MIDI Tx Channel>.

### 3. Turn the SONG [SELECT] knob to change the <MIDI Tx Channel>.

Setup Menu	
All Song Play:	On
Song Repeat:	Off
Melody Channel:	4
MIDI Tx Channel:	4

#### Settings (Channel)

1-16

### 4. Press the [MENU] button to complete the setting.

## USB driver settings (USB Driver)

Normally, you don't need to install a driver in order to connect the VIMA to your computer via the USB connector. However, if some problem occurs, or if the performance is poor, using the original Roland driver may solve the problem. If you do so, make the following setting to specify the USB driver you intend to use before you install the driver.

**MEMO** For details on downloading and installing the original driver, refer to the Roland website.

Roland website: <http://www.roland.com/>

**MEMO** For details on connecting the VIMA to your computer via its USB connector, refer to "Connecting your computer" (p. 54).

### 1. Press the [MENU] button so it's lit.

The Setup Menu screen appears.

### 2. Use the [LOCATION] buttons to select <USB Driver>.

### 3. Turn the SONG [SELECT] knob to change the <USB Driver>.



Setting	Explanation
Generic	Choose this if you want to use the standard USB driver that was included with your computer. Normally, you should use this mode. You do not need to install the driver.
Original	Choose this if you want to use a USB driver downloaded from the Roland website. You have to install the driver yourself.

### 4. Press the [MENU] button to complete the setting.

### 5. Turn the VIMA's volume to the minimum setting. Next, switch off the power, then turn it on again.

## Restoring the factory-set condition (Factory Reset)

You can restore the settings you've changed on the VIMA to their factory-set condition. This operation is called "Factory Reset."

**NOTE** When you perform a Factory Reset, all the settings you have stored will be erased, and the VIMA will return to the factory-set condition.

Use this operation with caution, since it will also erase all of the content you saved in "Favorites."

1. Switch off the VIMA's power.
2. While holding down the [MENU] button, switch on the VIMA's power. Press and continue holding down the [MENU] button until "Factory reset" appears in the screen.

The factory reset will be executed.

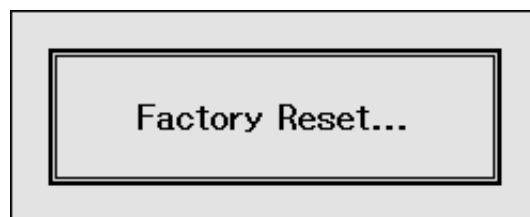

3. When the Factory Reset has been completed, switch off the VIMA's power, then turn it back on again.

**NOTE** Never turn off the power while the screen indicates "Factory Reset..." Doing so will destroy the VIMA's internal memory, rendering it unusable.

# Troubleshooting

If you think there's a problem, read this first.

Symptom	Cause/Action	Page
<b>Power does not turn on</b>	Is the AC adaptor connected correctly?	p. 14
<b>Nothing appears in the screen</b>	Since the VIMA uses a liquid crystal screen, it may happen that no text or graphics appear in the screen if the temperature is below zero degrees Celsius (32 degrees Fahrenheit).	–
<b>The screen shows vertical lines / Color is washed-out at the edge of the screen</b>	These are due to the nature of a liquid crystal screen, and are not malfunctions. You can adjust the screen brightness to minimize these artifacts.	p. 16
<b>Pedal does not work, or is "stuck"</b>	Is the pedal connected correctly? Plug the cable firmly into the pedal connector.	p. 39 p. 40
<b>Device connected to the input jacks has insufficient volume</b>	Could you be using a connection cable that contains a resistor? Use a connection cable that does not contain a resistor.	–
<b>No sound</b>		
<b>No sound</b>	Could the VIMA's volume or the volume of the connected equipment be turned down?	p. 15
	Could headphones be connected? Could there be a plug inserted in a headphone jack? The speakers will not produce sound if headphones (or anything else) are connected to the headphone jack.	p. 16
	Could the [BALANCE] knob be set all the way toward "KEYBOARD" or "SONG"?	p. 38
<b>No sound (when a MIDI device is connected)</b>	Are all devices powered on?	p. 50
	Are the MIDI cables connected correctly?	p. 53
	Do the MIDI channels of the VIMA and the connected device match?	p. 57
<b>Not all the notes you play are sounded</b>	The maximum simultaneous polyphony is 64 notes. If you are playing along with a song and making heavy use of the damper pedal, the number of notes the VIMA is attempting to produce may exceed the maximum polyphony, meaning that some of the notes will drop out.	–

## Troubleshooting

Symptom	Cause/Action	Page
<b>Notes don't sound right</b>		
<b>Pitch of the keyboard or song is incorrect</b>	Could you have made Key Control settings?	p. 47
<b>Keyboard volume is too low</b>	Could the [BALANCE] knob be all the way toward "SONG"?	p. 38
<b>The wrong instrument is selected when you press the [SCAT], [CHOIR], or [VIBRAPHONE] button</b>	The [SCAT], [CHOIR], and [VIBRAPHONE] buttons also function as buttons that select "Recommended tones". If the Setup Menu item <Recommended Tone> is "On," instrumental sounds appropriate for the song will automatically be assigned to these buttons, and can be selected by pressing the corresponding button.	p. 35 p. 55
<b>High-pitched ringing is heard</b>	If you hear this in headphones: Piano sounds that have a brilliant and crisp character contain substantial high-frequency components that may sound as though a metallic ringing has been added. This is because the character of an actual piano is being faithfully reproduced, and is not a malfunction.  If you don't hear this in headphones: It is likely that there is some other reason (such as resonances within the unit). Please contact your dealer or a nearby Roland service center.	–
<b>The sounds of multiple instruments are heard when you play the keyboard</b>	Could you have pressed the [DRUMS] button so the keyboard is set to play drum sounds? If the [DRUMS] button is lit, the white keys C2–B3 will play drum sounds. The black keys C#2–Bb3 will play sound effects, and keys C4–C7 will play the sound they were playing before you pressed the [DRUMS] button.	–
<b>Low notes sound wrong, or are buzzy</b>	If you don't hear this in headphones: Performing at high volumes may cause the speakers or objects near the piano to resonate. Fluorescent lights or glass doors may also resonate sympathetically. In particular, this is more likely to occur for lower notes and higher volumes. You can take the following measures to minimize resonances. <ul style="list-style-type: none"> <li>• Locate the speakers 10–15 cm away from walls or other surfaces.</li> <li>• Keep the volume down.</li> <li>• Move away from the objects that are resonating.</li> </ul> If you hear this in headphones: It is likely that there is some other reason. Please contact your dealer or a nearby Roland service center.	–

Symptom	Cause/Action	Page
<b>Song does not play correctly / Song won't play</b>		
<b>Can't play back a song from CD-ROM</b>	If you're using a CD-ROM you yourself made, could you have saved the song inside a folder? When using your computer to save songs on a CD-ROM, don't save the songs inside a folder.	–
<b>Can't select a song</b>	You can't select a song if no songs are saved in the selected location. For example, if no songs are saved in "FAVORITES" or if no CD-ROM is inserted, no song list will appear even if you choose "FAVORITES" or "CD-ROM" as the song location.	–
<b>Can't fast-forward or rewind by pressing the [◀◀] button or [▶▶] button</b>	You can't rewind or fast-forward while loading music data. Please wait.	–
	If you play back data containing performance data that exceeds the VIMA's storage capacity, there may be cases in which you will be unable to perform operations other than playback (e.g., fast-forward or rewind).	–
<b>The song from CD-ROM does not play back immediately</b>	SMF music data comes in two types; Formats 0 and 1. In the case of format 1 data, it may take a certain amount of time for playback to begin. The format type is indicated on the booklet for the music data you're using.	–
<b>Lyric display is wrong</b>	For some types of music data, the lyrics may sometimes be displayed incorrectly.	–
<b>Song tempo becomes unstable</b>	When playing a song, the tempo may become unstable if there is an excessive amount of performance data.	–
<b>The name of a CD-ROM song is not displayed</b>	Does the file contain song information (Sequence/Track Name Meta Event)? The song name will not be shown if the song information in the file is empty or consists only of spaces.	–
	Is the filename extension "MID"? Files with other filename extensions cannot be handled as song data.	–
	Is the filename eight or fewer single-byte characters? If the filename is longer than eight single-byte characters, the file cannot be correctly handled as song data.	–
<b>Accompaniment or song volume is low</b>	Could the [BALANCE] knob be set all the way toward "KEYBOARD"?	p. 38
<b>Can't hear the melody of the music data</b>	Could the [MUTE/CENTER CANCEL] button be lit? If the [MUTE/CENTER CANCEL] button is lit, the melody of the music data will be muted. Press the [MUTE/CENTER CANCEL] button to make the button go dark.	p. 41
<b>The vocal sound of a commercially available music CD is not eliminated when you press the Melody [MUTE/CENTER CANCEL] button</b>	For some commercially available music CDs, the vocal portion cannot be eliminated.	–

Symptom	Cause/Action	Page
<b>Something's wrong with the image in the connected television or external display</b>		
<b>The image does not appear in the connected external display</b>	Is the external display or television correctly connected?	p. 52
	Is the external display powered up?	p. 52
<b>Thin horizontal lines flicker in the television screen</b>	In some cases you may notice thin horizontal lines flickering in the television screen, but this is due to the nature of television and is not a malfunction of the VIMA.	–
<b>No image is shown in the external display</b>	Is your video source device correctly connected to the VIMA?	–
<b>Something's wrong with the sound from the microphone</b>		
<b>Mic volume is low or inaudible</b>	Is the mic connected correctly?	–
	Could the VOCAL [LEVEL] knob be set to the minimum position? The mic volume is adjusted with the VOCAL [LEVEL] knob, not the [VOLUME] knob.	p. 46
<b>Something's wrong with the sound from the microphone</b>	Could the [ECHO] button be lit? If the [ECHO] button is lit, echo (reverberation) is applied to the sound from the microphone.	p. 48

# If one of these messages appears

Indication	Meaning
<b>File Not Found</b>	CD-ROM is not inserted. Insert a CD-ROM, and try the operation again.
<b>Cannot Read</b>	An error occurred while reading. It is possible that the CD-ROM is damaged. Insert other CD-ROM and try the operation again.
<b>Illegal File</b>	The file cannot be read. The data format is not compatible with the VIMA.
<b>Memory Full</b>	The VIMA does not have enough storage capacity.
<b>Favorite Full</b>	The number of Favorites has reached the limit. Delete one of the items saved in Favorites, and try the operation again.
<b>File Too Big</b>	The file size exceeds the maximum permissible size. The VIMA cannot handle this file.
<b>Too Many Tracks</b>	The number of song tracks exceeds the limit. The VIMA cannot play back this song correctly.
<b>Too Many Lyrics</b>	The amount of lyric data in the song exceeds the limit. The VIMA cannot play back this song correctly.
<b>MIDI Buffer Full</b>	A large amount of MIDI data was received from an external MIDI device faster than the VIMA was able to process it. Reduce the amount of data being sent by the external MIDI device.
<b>MIDI Off Line</b>	A MIDI cable has been disconnected, or a similar problem has occurred. Connect the MIDI cable correctly.
<b>MIDI Error</b>	A MIDI communication error has occurred. Check the MIDI cable connection and the MIDI device that is connected.
<b>Failed</b>	It is possible that there is a problem with the system. Try the operation once again. If this indication appears even after you've tried the operation several times, please contact a Roland service center.

# Tone List

## Piano

NaturalGrand  
Piano 1  
Piano 1w  
Piano 1d  
Piano 2  
Piano 2w  
Piano 3  
Piano 3w  
Honky-tonk  
Honky-tonk w  
E.Piano 1  
E.Piano 2  
Detuned EP 1  
Detuned EP 2  
'60s E.Piano  
EP Legend  
EP Phase  
FM+SA EP  
St.FM EP  
Harpsichord  
Coupled Hps.  
Harpsi.w  
Harpsi.o  
Clav.  
Pulse Clav.

## Organ

Perc.Organ 1  
Perc.Organ 2  
Organ 1  
Organ 2  
TremoloOrgan  
Chorus Organ  
Rock Organ  
'60s Organ  
Church Org.1  
Church Org.2  
Church Org.3  
Reed Organ  
Puff Organ  
Accordion 1  
Accordion 2  
Harmonica  
Bandoneon

## Strings

Mood Strings  
Strings  
Slow Strings  
Tremolo Str.  
PizzicatoStr  
'60s Strings  
Orchestra  
Violin  
Slow Violin  
Viola  
Cello  
Contrabass  
Syn.Strings1  
Syn.Strings2  
Syn.Strings3  
Harp  
Koto  
Taisho Koto  
Fiddle

## Guitar

Nylon-str.Gt  
Nylon Gt 2  
Nylon Gt o  
Ukulele  
Steel-str.Gt  
12-str.Gt  
Steel + Body  
Combo JazzGt  
Jazz Guitar  
Hawaiian Gt  
Clean Guitar  
Chorus Gt 1  
Chorus Gt 2  
Mid Tone Gt  
Muted Guitar  
Funk Guitar1  
Funk Guitar2  
Overdrive Gt  
Guitar Pinch  
DistortionGt  
Gt Feedback1  
Gt Feedback2  
Dist.Rtm Gt  
Gt Harmonics  
AcousticBass  
FingeredBass  
Finger Slap  
Picked Bass  
FretlessBass  
Slap Bass 1  
Slap Bass 2  
Mandolin  
Banjo  
Sitar 1  
Sitar 2  
Shamisen

## Brass/Sax

Trumpet  
Dark Trumpet  
Romantic Tp  
Mariachi Tp  
MuteTrumpet1  
MuteTrumpet2  
Trombone 1  
Trombone 2  
Bright Tb  
Soprano Sax  
BlowAltoVib.  
Alto Sax  
TenorSaxVib.  
Tenor Sax  
Baritone Sax  
French Horn1  
French Horn2  
Tuba  
Brass 1  
Brass 2  
Synth Brass 1  
Synth Brass2  
Synth Brass3  
Synth Brass4  
AnalogBrass1  
AnalogBrass2  
Jump Brass

## Woodwinds

Flute  
Piccolo  
Recorder  
Pan Flute  
Oboe  
Clarinet  
English Horn  
Bassoon  
Bottle Blow  
Shakuhachi  
Whistle  
Ocarina  
Bagpipe  
Shanai



**Percussion**

Celesta  
 Glockenspiel  
 Music Box  
 Vibraphone  
 Vibraphone w  
 Marimba  
 Marimba w  
 Xylophone  
 TubularBells  
 Church Bell  
 Carillon  
 Santur  
 Yang Qin  
 Timpani  
 Kalimba  
 Tinkle Bell  
 Agogo  
 Steel Drums  
 Woodblock  
 Castanets  
 Taiko  
 Concert BD  
 Melodic Tom1  
 Melodic Tom2  
 Synth Drum  
 TR-808 Tom  
 Elec Perc.  
 Reverse Cym.

(Rhythm Set)  
 STANDARD Set  
 ROOM Set  
 POWER Set  
 ELEC.Set  
 ANALOG Set  
 JAZZ Set  
 BRUSH Set  
 ORCH.Set  
 SFX Set

**Others**

Choir 1  
 Choir 2  
 Voice  
 Humming  
 Jazz Scat  
 Synth Voice  
 Analog Voice  
 Synth Bass 1  
 Synth Bass 2  
 Synth Bass 3  
 Synth Bass 4  
 WarmSyn.Bass  
 Clav.Bass  
 Hammer  
 RubberSyn.Bs  
 Attack Pulse  
 OrchestraHit  
 Bass Hit  
 6th Hit  
 Euro Hit  
 Square Lead 1  
 Square Lead2  
 Sine Lead  
 Saw Lead 1  
 Saw Lead 2  
 Doctor Solo  
 Natural Lead  
 SequencedSaw  
 Syn.Calliope  
 Chiffer Lead  
 Charang  
 Wire Lead  
 Solo Vox  
 5th Saw Lead  
 Bass + Lead  
 Delayed Lead  
 Fantasia  
 Warm Pad  
 Sine Pad  
 Polysynth  
 Space Voice  
 Itopia  
 Bowed Glass  
 Metallic Pad  
 Halo Pad  
 Sweep Pad  
 Ice Rain  
 Soundtrack  
 Crystal

Synth Mallet  
 Atmosphere  
 Brightness  
 Goblins  
 Echo Drops  
 Echo Bell  
 Echo Pan  
 Star Theme  
 Gt FretNoise  
 Gt Cut Noise  
 BsStringSlap  
 Breath Noise  
 Fl.Key Click  
 Seashore  
 Rain  
 Thunder  
 Wind  
 Stream  
 Bubble  
 Bird 1  
 Bird 2  
 Dog  
 Horse Gallop  
 Telephone 1  
 Telephone 2  
 DoorCreaking  
 Door  
 Scratch  
 Wind Chimes  
 Helicopter  
 Car Engine  
 Car Stop  
 Car Pass  
 Car Crash  
 Siren  
 Train  
 Jet Plane  
 Starship  
 Burst Noise  
 Applause  
 Laughing  
 Screaming  
 Punch  
 Heart Beat  
 Footsteps  
 Gun Shot  
 Machine Gun  
 Laser Gun  
 Explosion

# Tone List

	STANDARD Set	ROOM Set	POWER Set	ELEC.Set
28	27 High Q Slap	High Q Slap	High Q Slap	High Q Slap
29	Scratch Push [EXC7]	Scratch Push [EXC7]	Scratch Push [EXC7]	Scratch Push [EXC7]
30	Scratch Pull [EXC7]	Scratch Pull [EXC7]	Scratch Pull [EXC7]	Scratch Pull [EXC7]
31	Sticks	Sticks	Sticks	Sticks
32	Square Click	Square Click	Square Click	Square Click
33	Metronome Click	Metronome Click	Metronome Click	Metronome Click
34	Metronome Bell	Metronome Bell	Metronome Bell	Metronome Bell
35	Kick Drum 2	Room Kick 2	Power Kick 2	Electric Kick 2
C2 36	Kick Drum 1	Room Kick 1	Power Kick 1	Electric Kick 1
37	Side Stick	Side Stick	Side Stick	Side Stick
38	Snare Drum	Room Snare	Dance Snare	Electric Snare 1
39	TR-909 Clap	TR-909 Clap	TR-909 Clap	TR-909 Clap
40	Electric Snare 3	Electric Snare 3	Electric Snare 3	Electric Snare 2
41	Low Tom 2	Room Low Tom 2	Power Low Tom 2	Electric Low Tom 2
42	Closed Hi-Hat [EXC1]	Closed Hi-Hat [EXC1]	Closed Hi-Hat [EXC1]	Closed Hi-Hat [EXC1]
43	Low Tom 1	Room Low Tom 1	Power Low Tom 1	Electric Low Tom 1
44	Pedal Hi-Hat [EXC1]	Pedal Hi-Hat [EXC1]	Pedal Hi-Hat [EXC1]	Pedal Hi-Hat [EXC1]
45	Mid Tom 2	Room Mid Tom 2	Power Mid Tom 2	Electric Mid Tom 2
46	Open Hi-Hat [EXC1]	Open Hi-Hat [EXC1]	Open Hi-Hat [EXC1]	Open Hi-Hat [EXC1]
47	Mid Tom 1	Room Mid Tom 1	Power Mid Tom 1	Electric Mid Tom 1
C3 48	High Tom 2	Room High Tom 2	Power High Tom 2	Electric High Tom 2
49	Crash Cymbal 1	Crash Cymbal 1	Crash Cymbal 1	Crash Cymbal 1
50	High Tom 1	Room High Tom 1	Power High Tom 1	Electric High Tom 1
51	Ride Cymbal	Ride Cymbal	Ride Cymbal	Ride Cymbal
52	Chinese Cymbal	Chinese Cymbal	Chinese Cymbal	Reverse Cymbal
	Ride Bell	Ride Bell	Ride Bell	Ride Bell
54	Tambourine	Tambourine	Tambourine	Tambourine
55	Splash Cymbal	Splash Cymbal	Splash Cymbal	Splash Cymbal
56	Cowbell	Cowbell	Cowbell	Cowbell
57	Crash Cymbal 2	Crash Cymbal 2	Crash Cymbal 2	Crash Cymbal 2
58	Vibra-slap	Vibra-slap	Vibra-slap	Vibra-slap
59	Ride Cymbal	Ride Cymbal	Ride Cymbal	Ride Cymbal
C4 60	High Bongo	High Bongo	High Bongo	High Bongo
61	Low Bongo	Low Bongo	Low Bongo	Low Bongo
62	Mute High Conga	Mute High Conga	Mute High Conga	Mute High Conga
63	Open High Conga	Open High Conga	Open High Conga	Open High Conga
64	Low Conga	Low Conga	Low Conga	Low Conga
	High Timbale	High Timbale	High Timbale	High Timbale
66	Low Timbale	Low Timbale	Low Timbale	Low Timbale
67	High Agogo	High Agogo	High Agogo	High Agogo
68	Low Agogo	Low Agogo	Low Agogo	Low Agogo
69	Cabasa	Cabasa	Cabasa	Cabasa
70	Maracas	Maracas	Maracas	Maracas
71	Short High Whistle [EXC2]	Short High Whistle [EXC2]	Short High Whistle [EXC2]	Short High Whistle [EXC2]
C5 72	Long Low Whistle [EXC2]	Long Low Whistle [EXC2]	Long Low Whistle [EXC2]	Long Low Whistle [EXC2]
73	Short Guiro [EXC3]	Short Guiro [EXC3]	Short Guiro [EXC3]	Short Guiro [EXC3]
74	Long Guiro [EXC3]	Long Guiro [EXC3]	Long Guiro [EXC3]	Long Guiro [EXC3]
75	Claves	Claves	Claves	Claves
76	High Woodblock	High Woodblock	High Woodblock	High Woodblock
	Low Woodblock	Low Woodblock	Low Woodblock	Low Woodblock
78	Mute Cuica [EXC4]	Mute Cuica [EXC4]	Mute Cuica [EXC4]	Mute Cuica [EXC4]
79	Open Cuica [EXC4]	Open Cuica [EXC4]	Open Cuica [EXC4]	Open Cuica [EXC4]
80	Mute Triangle [EXC5]	Mute Triangle [EXC5]	Mute Triangle [EXC5]	Mute Triangle [EXC5]
81	Open Triangle [EXC5]	Open Triangle [EXC5]	Open Triangle [EXC5]	Open Triangle [EXC5]
82	Shaker	Shaker	Shaker	Shaker
83	Jingle Bell	Jingle Bell	Jingle Bell	Jingle Bell
C6 84	Bell Tree	Bell Tree	Bell Tree	Bell Tree
85	Castanets	Castanets	Castanets	Castanets
86	Mute Surdo [EXC6]	Mute Surdo [EXC6]	Mute Surdo [EXC6]	Mute Surdo [EXC6]
87	Open Surdo [EXC6]	Open Surdo [EXC6]	Open Surdo [EXC6]	Open Surdo [EXC6]
88	-----	-----	-----	-----

\* -----: No sound.

\* [EXC]: will not sound simultaneously with other percussion instruments of the same number.

	ANALOG Set	JAZZ Set	BRUSH Set	ORCH.Set
28	27 High Q Slap	High Q Slap	High Q Slap	Jazz Closed Hi-Hat [EXC1] Jazz Pedal Hi-Hat [EXC1]
29	Scratch Push [EXC7]	Scratch Push [EXC7]	Scratch Push [EXC7]	Jazz Open Hi-Hat [EXC1]
30	Scratch Pull [EXC7]	Scratch Pull [EXC7]	Scratch Pull [EXC7]	Ride Cymbal
31	Sticks	Sticks	Sticks	Sticks
32	Square Click	Square Click	Square Click	Square Click
33	Metronome Click	Metronome Click	Metronome Click	Metronome Click
34	Metronome Bell	Metronome Bell	Metronome Bell	Metronome Bell
35	TR-909 Kick	Jazz Kick 2	Jazz Kick 2	Concert Bass Drum 2
C2 36	TR-808 Kick	Jazz Kick 1	Jazz Kick 1	Concert Bass Drum 1
37	TR-808 Rim Shot	Side Stick	Side Stick	Side Stick
38	TR-808 Snare	Jazz Snare	Brush Tap	Concert Snare Drum
39	TR-808 Clap	TR-909 Clap	Brush Slap	Castanets
40	Electric Snare 3	Electric Snare 3	Brush Swirl	Concert Snare Drum
41	TR-808 Low Tom 2	Low Tom 2	Brush Low Tom 2	Timpani F
42	TR-808 Closed Hi-Hat [EXC1]	Jazz Closed Hi-Hat [EXC1]	Brush Closed Hi-Hat [EXC1]	Timpani F#
43	TR-808 Low Tom 1	Low Tom 1	Brush Low Tom 1	Timpani G
44	TR-808 Closed Hi-Hat [EXC1]	Jazz Pedal Hi-Hat [EXC1]	Jazz Pedal Hi-Hat [EXC1]	Timpani G#
45	TR-808 Mid Tom 2	Mid Tom 2	Brush Mid Tom 2	Timpani A
46	TR-808 Open Hi-Hat [EXC1]	Jazz Open Hi-Hat [EXC1]	Brush Open Hi-Hat [EXC1]	Timpani A#
47	TR-808 Mid Tom 1	Mid Tom 1	Brush Mid Tom 1	Timpani B
C3 48	TR-808 High Tom 2	High Tom 2	Brush High Tom 2	Timpani c
49	TR-808 Crash Cymbal	Crash Cymbal 1	Brush Crash Cymbal	Timpani c#
50	TR-808 High Tom 1	High Tom 1	Brush High Tom 1	Timpani d
51	Ride Cymbal	Ride Cymbal	Brush Ride Cymbal	Timpani d#
52	Chinese Cymbal	Chinese Cymbal	Chinese Cymbal	Timpani e
53	Ride Bell	Ride Bell	Brush Ride Bell	Timpani f
54	Tambourine	Tambourine	Tambourine	Tambourine
55	Splash Cymbal	Splash Cymbal	Splash Cymbal	Splash Cymbal
56	TR-808 Cowbell	Cowbell	Cowbell	Cowbell
57	Crash Cymbal 2	Crash Cymbal 2	Crash Cymbal 2	Concert Cymbal 2
58	Vibra-slap	Vibra-slap	Vibra-slap	Vibra-slap
59	Ride Cymbal	Ride Cymbal	Ride Cymbal	Concert Cymbal 1
C4 60	High Bongo	High Bongo	High Bongo	High Bongo
61	Low Bongo	Low Bongo	Low Bongo	Low Bongo
62	TR-808 High Conga	Mute High Conga	Mute High Conga	Mute High Conga
63	TR-808 Mid Conga	Open High Conga	Open High Conga	Open High Conga
64	TR-808 Low Conga	Low Conga	Low Conga	Low Conga
65	High Timbale	High Timbale	High Timbale	High Timbale
66	Low Timbale	Low Timbale	Low Timbale	Low Timbale
67	High Agogo	High Agogo	High Agogo	High Agogo
68	Low Agogo	Low Agogo	Low Agogo	Low Agogo
69	Cabasa	Cabasa	Cabasa	Cabasa
70	TR-808 Maracas	Maracas	Maracas	Maracas
71	Short High Whistle [EXC2]	Short High Whistle [EXC2]	Short High Whistle [EXC2]	Short High Whistle [EXC2]
C5 72	Long Low Whistle [EXC2]	Long Low Whistle [EXC2]	Long Low Whistle [EXC2]	Long Low Whistle [EXC2]
73	Short Guiro [EXC3]	Short Guiro [EXC3]	Short Guiro [EXC3]	Short Guiro [EXC3]
74	Long Guiro [EXC3]	Long Guiro [EXC3]	Long Guiro [EXC3]	Long Guiro [EXC3]
75	TR-808 Claves	Claves	Claves	Claves
76	High Woodblock	High Woodblock	High Woodblock	High Woodblock
77	Low Woodblock	Low Woodblock	Low Woodblock	Low Woodblock
78	Mute Cuica [EXC4]	Mute Cuica [EXC4]	Mute Cuica [EXC4]	Mute Cuica [EXC4]
79	Open Cuica [EXC4]	Open Cuica [EXC4]	Open Cuica [EXC4]	Open Cuica [EXC4]
80	Mute Triangle [EXC5]	Mute Triangle [EXC5]	Mute Triangle [EXC5]	Mute Triangle [EXC5]
81	Open Triangle [EXC5]	Open Triangle [EXC5]	Open Triangle [EXC5]	Open Triangle [EXC5]
82	Shaker	Shaker	Shaker	Shaker
83	Jingle Bell	Jingle Bell	Jingle Bell	Jingle Bell
C6 84	Bell Tree	Bell Tree	Bell Tree	Bell Tree
85	Castanets	Castanets	Castanets	Castanets
86	Mute Surdo [EXC6]	Mute Surdo [EXC6]	Mute Surdo [EXC6]	Mute Surdo [EXC6]
87	Open Surdo [EXC6]	Open Surdo [EXC6]	Open Surdo [EXC6]	Open Surdo [EXC6]
88	-----	-----	-----	Applause

\* -----: No sound.

\* [EXC]: will not sound simultaneously with other percussion instruments of the same number.

# Tone List

SFX Set	
28	27 -----
	-----
29	30 -----
31	-----
	32 -----
33	-----
	34 -----
35	-----
C2	
36	-----
	37 -----
38	-----
	39 High Q
40	Slap
	Scratch Push [EXC7]
41	Scratch Pull [EXC7]
	42 Sticks
43	44 Square Click
45	Metronome Click
	46 Metronome Bell
47	Guitar Fret Noise
C3	
48	Guitar Cutting Noise Up
	49 Guitar Cutting Noise Down
50	String Slap of Double Bass
	51 Fl.Key Click
52	Laughing
	Screaming
53	54 Punch
55	Heart Beat
	56 Footsteps 1
57	Footsteps 2
	58 Applause
59	Door Creaking
C4	
60	Door
	61 Scratch
62	Wind Chimes
	63 Car Engine
64	Car Stop
	Car Pass
65	66 Car Crash
67	Siren
	68 Train
69	Jet Plane
	70 Helicopter
71	Starship
C5	
72	Gun Shot
	73 Machine Gun
74	Laser Gun
	75 Explosion
76	Dog
	Horse Gallop
77	78 Birds
79	Rain
	80 Thunder
81	Wind
	82 Seashore
83	Stream
C6	
84	Bubble
	85 -----
86	-----
	87 -----
88	-----

\* -----: No sound.

\* [EXC]: will not sound simultaneously with other percussion instruments of the same number.

# Internal Song List

\* All rights reserved. Unauthorized use of this material for purposes other than private, personal enjoyment is a violation of applicable laws.

<b>1</b>	American Patrol
<b>2</b>	Bill Bailey, Won't You Please Come Home?
<b>3</b>	Can Can
<b>4</b>	Turkey in the Straw
<b>5</b>	Yankee Doodle Boy
<b>6</b>	Yellow Rose of Texas
<b>7</b>	Abide with Me
<b>8</b>	Amazing Grace
<b>9</b>	When The Saints Go Marchin' In
<b>10</b>	Away In A Manger
<b>11</b>	Deck The Halls
<b>12</b>	O Little Town of Bethlehem
<b>13</b>	We Wish You A Merry Christmas
<b>14</b>	Jingle Bells
<b>15</b>	Silent Night, Holy Night
<b>16</b>	Joy To The World
<b>17</b>	Aloha Oe
<b>18</b>	America
<b>19</b>	America The Beautiful
<b>20</b>	For He's A Jolly Good Fellow

<b>21</b>	Let Me Call You Sweetheart
<b>22</b>	Star Spangled Banner
<b>23</b>	Entertainer
<b>24</b>	Stagecoach
<b>25</b>	Little Brown Jug
<b>26</b>	Old MacDonald Had A Farm
<b>27</b>	Twinkle Twinkle, Little Star
<b>28</b>	Mary Had A Little Lamb
<b>29</b>	London Bridge
<b>30</b>	Liebesträume 3
<b>31</b>	Fantaisie-Impromptu
<b>32</b>	Arabesque 1
<b>33</b>	An der schonen, blauen Donau
<b>34</b>	Clair de Lune

# Music Files That the VIMA Can Use

## What Are Music Files?

Music files contains musical information such as how long the key for a corresponding pitch is played, the force applied to the key played, and other such information. Performance data is transmitted to the VIMA from music files saved in a CD-ROM and played back without change as songs. This is different than an audio CD, since the music file does not contain a recording of the sound itself. This makes it possible to change tempos and keys freely, allowing you to use it in many different ways.

## Regarding Copyright

Use of the song data supplied with the Data Disk attached to this product for any purpose other than private, personal enjoyment without the permission of the copyright holder is prohibited by law. Additionally, this data must not be copied, nor used in a secondary copyrighted work without the permission of the copyright holder.

## The VIMA Allows You To Use the Following Music Files

.....

### VIMA TUNES

VIMA TUNES is a Roland specification for music data that contains image and lyric data, allowing you to enjoy songs with lyrics and images simultaneously. When data bearing the "VIMA TUNES" logo is played back on a device that bears the same logo, lyrics can be shown on the screen of a connected external display or television, letting you enjoy karaoke or watch a slide show.

\* This instrument (RK-100) is not able to play back VIMA TUNES images.

### SMF Music Files

SMFs (Standard MIDI Files) use a standard format for music file that was formulated so that files containing music file could be widely compatible, regardless of the manufacturer of the listening device. An enormous variety of music is available, whether it be for listening, for practicing musical instruments, for Karaoke, etc.

### SMF with Lyrics

"SMF with Lyrics" refers to SMF (Standard MIDI File) that contains the lyrics. When Music Files carrying the "SMF with Lyrics" logo are played back on the VIMA, the lyrics will appear in its display.

### General MIDI

The General MIDI is a set of recommendations which seeks to provide a way to go beyond the limitations of proprietary designs, and standardize the MIDI capabilities of sound generating devices. Sound generating devices and music files that meets the General MIDI standard bears the General MIDI logo. Music files bearing the General MIDI logo can be played back using any General MIDI sound generating unit to produce essentially the same musical performance.

### General MIDI 2

The upwardly compatible General MIDI 2 recommendations pick up where the original General MIDI left off, offering enhanced expressive capabilities, and even greater compatibility. Issues that were not covered by the original General MIDI recommendations, such as how sounds are to be edited, and how effects should be handled, have now been precisely defined. Moreover, the available sounds have been expanded. General MIDI 2 compliant sound generators are capable of reliably playing back music files that carry either the General MIDI or General MIDI 2 logo. In some cases, the conventional form of General MIDI, which does not include the new enhancements, is referred to as "General MIDI 1" as a way of distinguishing it from General MIDI 2.

### GS Format

The GS Format is Roland's set of specifications for standardizing the performance of sound generating devices. In addition to including support for everything defined by the General MIDI, the highly compatible GS Format additionally offers an expanded number of sounds, provides for the editing of sounds, and spells out many details for a wide range of extra features, including effects such as reverb and chorus. Designed with the future in mind, the GS Format can readily include new sounds and support new hardware features when they arrive. Since it is upwardly compatible with the General MIDI, Roland's GS Format is capable of reliably playing back GM Scores equally as well as it performs GS music files (music files that have been created with the GS Format in mind).

### XG lite

XG is a tone generator format of YAMAHA Corporation, that defines the ways in which voices are expanded or edited and the structure and type of effects, in addition to the General MIDI 1 specification. XGLite is a simplified version of XG tone generation format. You can play back any XG music files using an XGLite tone generator. However, keep in mind that some music files may play back differently compared to the original files, due to the reduced set of control parameters and effects.

## MIDI Implementation Chart

Function...		Transmitted	Recognized	Remarks
Basic Channel	Default Changed	4 1-16	1-16 1-16	
Mode	Default Messages Altered	Mode 3 x *****	Mode 3 Mode 3, 4(M=1)	* 2
Note Number :	True Voice	30-101 *****	0-127 0-127	
Velocity	Note ON Note OFF	O x	O x	
After Touch	Key's Ch's	x x	O *1 O *1	
Pitch Bend		O	O *1	
Control Change		0, 32 1 5 6, 38 7 10 11 64 65 66 67 84 91 93 98, 99 100, 101	O *1 O *1 O *1 O *1 O *1 O *1 O *1 O *1 O *1 O *1 O *1 O *1 O *1 O *1 O (Reverb) *1 O (Chorus) *1 O *1 O *1	Bank select Modulation Portamento time Data entry Volume Panpot Expression Hold 1 Portamento Sostenuto Soft Portamento control Effect1 depth Effect3 depth NRPN LSB, MSB RPN LSB, MSB
Prog Change :	True #	0-127 *****	O *1 0-127	Program number 1-128
System Exclusive		O	O	
System Common	: Song Pos : Song Sel : Tune	x x x	x x x	
System Real Time	: Clock : Commands	O x	x x	
Aux Message	: All sound off : Reset all controllers : Local Control : All Notes OFF : Active Sense : Reset	x x x x O x	O (120, 126, 127) O O O (123-125) O x	
Notes	* 1 O x is selectable by Sys Ex. * 2 Recognized as M=1 even if M≠1.			

Mode 1 : OMNI ON, POLY    Mode 2 : OMNI ON, MONO  
Mode 3 : OMNI OFF, POLY    Mode 4 : OMNI OFF, MONO

O : Yes  
X : No

# Main Specifications

<b>[Keyboard]</b>	
Keyboard	61 keys (with velocity)
<b>[Sound Generator]</b>	
Maximum Polyphony	64 voices
Parts	16 parts + Keyboard part
Wave Memory	32 M bytes (16-bit linear equivalent)
Tones	Tones: 264 Drum Sets: 8 Drum sets + Sound Effects, Manual Drums GM2/GM/GS/XG lite Format
<b>[Song Controls]</b>	
Tempo	50-200%
Key Control	-6 to +5 (in semitones)

<b>[Others]</b>	
CD Drive	Media: CD-ROM, Music CD
USB (MIDI)	Operating System Windows XP Home Edition SP2 or later/ XP Professional Edition SP2 or later Mac OS X v10.2 or later
Rated Power Output	14.8 W + 14.8 W
Speakers	10 cm x 2
Display	240 x 92 dots (backlit graphic LCD)
Connectors	Audio Output Jacks (L/MONO, R) Video Output Jack Phones Jacks 1/2 Vocal Jacks 1/2 MIDI Connectors (IN, OUT) Expression Pedal Jack Damper Pedal Jack USB Connector EXT IN (VIDEO, L/R) Jacks
Power Supply	DC 12 V (AC Adaptor)
Current Draw	4000 mA
Dimensions	1119 (W) x 378 (D) x 144 (H) mm 44-1/16 (W) x 14-15/16 (D) x 5-11/16 (H) inches
Weight	9.2 kg / 20 lbs 5 oz (excluding AC adaptor)
Accessories	Music Rest Owner's Manual "Roland Photo & Music - Sample Disc" VIMA TUNES CD-ROM Note ID Label (two types) Drum Key-Map Label AC Adaptor (PSB-7U)
Options	Keyboard Stand: KS-RK100 Pedal Switch: DP Series Expression Pedal: EV-5

\* In the interest of product improvement, the specifications and/or appearance of this unit are subject to change without prior notice.



- A**  
Adjusting  
  Brightness ..... 16  
  Tempo ..... 21  
  Volume ..... 15, 46  
All song Play ..... 56  
Audio equipment ..... 50  
AUDIO OUTPUT L/R jack ..... 12
- B**  
[BALANCE] knob ..... 10
- C**  
CD drive ..... 11  
Center cancel ..... 49  
Changing  
  Key ..... 47  
Computer ..... 54  
Connecting  
  Audio equipment ..... 50  
  Computer ..... 54  
  Damper pedal ..... 40  
  Expression pedal ..... 39  
  Headphones ..... 16  
  Microphone ..... 45  
  MIDI equipment ..... 53  
  Power cord ..... 14  
  Speakers ..... 50  
  Television ..... 52  
Contrast ..... 16  
Copying  
  Favorites ..... 30  
Cord hook ..... 12  
Count sounds ..... 37
- D**  
Damper pedal ..... 40  
DAMPER PEDAL jack ..... 12  
DC IN jack ..... 12  
Deleting  
  Favorites ..... 32  
[DEMO] button ..... 11  
Demo song ..... 18  
Display ..... 11  
[DISPLAY CONTRAST] knob ..... 10
- E**  
Echo ..... 48  
Emergency eject hole ..... 25, 29  
Expression pedal ..... 39  
EXPRESSION PEDAL jack ..... 12  
EXT IN ..... 10
- F**  
Factory reset ..... 58  
FAVORITES ..... 30
- G**  
General MIDI ..... 70  
General MIDI 2 ..... 70  
Ground terminal ..... 12  
GS ..... 70  
GS format ..... 70
- I**  
INSTRUMENT ..... 11  
Internal Song ..... 69  
Internal Song List ..... 69  
Internal song list ..... 69  
Internal songs ..... 19
- K**  
KEY ..... 13  
KEY CONTROL ..... 10  
Key control ..... 47
- L**  
Location ..... 17
- M**  
MELODY ..... 10  
Melody channel ..... 42, 57  
Melody guide ..... 42  
Melody mute ..... 41  
[MENU] button ..... 11  
Microphone ..... 45  
MIDI equipment ..... 53  
MIDI IN/OUT connectors ..... 12  
MIDI Tx channel ..... 57  
Music files ..... 70  
Music rest ..... 15  
Muting  
  Melody ..... 41

# Index

---

## P

Percussion instruments .....	34
PHONES jacks .....	12
PLAYER .....	11
Playing	
CD-ROM .....	22
Favorites .....	30–31
Music CD .....	26
Percussion instruments .....	34
Preset .....	20
Recommended tone .....	35
Sound effects .....	34
Power .....	14
Power cord .....	14
[Power On] switch .....	10
PRESETS .....	19

## R

Recommended tone .....	35, 55
------------------------	--------

## S

Saving	
Favorites .....	30
Selecting	
Instruments .....	43
Recommended tones .....	35
Sound .....	33
SMF with Lyrics .....	70
SONG .....	11
SONG LOCATION .....	13
Song repeat .....	56
SONG/LYRIC .....	13
Sound effects .....	34

## T

Television .....	52
TEMPO .....	13
Tempo .....	21
[TEMPO] knob .....	10
Tone list .....	43, 55, 64
Troubleshooting .....	59

## U

USB connector .....	12
USB driver .....	58

## V

VIDEO OUTPUT jack .....	12
VIMA TUNES .....	70
VOCAL .....	10
VOCAL jacks .....	11
Volume	
Microphones .....	46
Volume balance .....	38
[VOLUME] knob .....	10

## X

XG lite .....	70
---------------	----



This product complies with the requirements of European Directive 89/336/EEC.

For EU Countries

## FEDERAL COMMUNICATIONS COMMISSION RADIO FREQUENCY INTERFERENCE STATEMENT

For the USA

This equipment has been tested and found to comply with the limits for a Class B digital device, pursuant to Part 15 of the FCC Rules. These limits are designed to provide reasonable protection against harmful interference in a residential installation. This equipment generates, uses, and can radiate radio frequency energy and, if not installed and used in accordance with the instructions, may cause harmful interference to radio communications. However, there is no guarantee that interference will not occur in a particular installation. If this equipment does cause harmful interference to radio or television reception, which can be determined by turning the equipment off and on, the user is encouraged to try to correct the interference by one or more of the following measures:

- Reorient or relocate the receiving antenna.
- Increase the separation between the equipment and receiver.
- Connect the equipment into an outlet on a circuit different from that to which the receiver is connected.
- Consult the dealer or an experienced radio/TV technician for help.

This device complies with Part 15 of the FCC Rules. Operation is subject to the following two conditions:

- (1) This device may not cause harmful interference, and
- (2) This device must accept any interference received, including interference that may cause undesired operation.

Unauthorized changes or modification to this system can void the users authority to operate this equipment.  
This equipment requires shielded interface cables in order to meet FCC class B Limit.

For Canada

### NOTICE

This Class B digital apparatus meets all requirements of the Canadian Interference-Causing Equipment Regulations.

### AVIS

Cet appareil numérique de la classe B respecte toutes les exigences du Règlement sur le matériel brouilleur du Canada.

For the U.K.

**IMPORTANT:** THE WIRES IN THIS MAINS LEAD ARE COLOURED IN ACCORDANCE WITH THE FOLLOWING CODE.

BLUE: NEUTRAL  
BROWN: LIVE

As the colours of the wires in the mains lead of this apparatus may not correspond with the coloured markings identifying the terminals in your plug, proceed as follows:

The wire which is coloured BLUE must be connected to the terminal which is marked with the letter N or coloured BLACK.

The wire which is coloured BROWN must be connected to the terminal which is marked with the letter L or coloured RED.

Under no circumstances must either of the above wires be connected to the earth terminal of a three pin plug.

For the USA

## DECLARATION OF CONFORMITY Compliance Information Statement

Model Name : RK-100  
Type of Equipment : Digital Keyboard  
Responsible Party : Roland Corporation U.S.  
Address : 5100 S. Eastern Avenue, Los Angeles, CA 90040-2938  
Telephone : (323) 890-3700



This product must be disposed of separately  
at your local waste recycling centre.  
Do not dispose of in household waste bin.

## Information

When you need repair service, call your nearest Roland Service Center or authorized Roland distributor in your country as shown below.

### AFRICA

#### EGYPT

**A1 Fanny Trading Office**  
9, EBN Hagar A1 Askalany Street,  
ARD E1 Golf, Heliopolis, Cairo 11341, EGYPT  
TEL: 20-2-417-1828

#### REUNION

**Maison FO - YAM Marcel**  
25 Rue Jules Hermann, Chaudron - BP79 97 491 Ste Clotilde Cedex, REUNION ISLAND  
TEL: (0262) 218-429

#### SOUTH AFRICA

**T.O.M.S. Sound & Music (Pty)Ltd.**

11 Melle St., Braamfontein, Johannesburg, SOUTH AFRICA  
TEL: (011) 403 4105  
FAX: (011) 403 1234

**Paul Bothner(PTY)Ltd.**  
Royal Cape Park, Unit 24 Londonderry Road, Ottery 7800 Cape Town, SOUTH AFRICA  
TEL: (021) 799 4900

### ASIA

#### CHINA

**Roland Shanghai Electronics Co.,Ltd.**  
5F, No.1500 Pingliang Road Shanghai 200090, CHINA  
TEL: (021) 5580-0800

**Roland Shanghai Electronics Co.,Ltd.**  
**(BEIJING OFFICE)**  
10F, No.18 3 Section Anhuaxili Chaoyang District Beijing 100011 CHINA  
TEL: (010) 6426-5050

#### HONG KONG

**Tom Lee Music Co., Ltd. Service Division**  
22-32 Pun Shan Street, Tsuen Wan, New Territories, HONG KONG  
TEL: 2415 0911

**Parsons Music Ltd.**  
8th Floor, Railway Plaza, 39 Chatham Road South, T.S.T., Kowloon, HONG KONG  
TEL: 2333 1863

#### INDIA

**Rivera Digitec (India) Pvt. Ltd.**  
409, Nirmam Kendra Mahalaxmi Flats Compound Off. Dr. Edwin Moses Road, Mumbai-400011, INDIA  
TEL: (022) 2493 9051

#### INDONESIA

**PT Citra IntiRama**  
Jl. Cideng Timur No. 15J-150 Jakarta Pusat  
INDONESIA  
TEL: (021) 6324170

#### KOREA

**Cosmos Corporation**  
1461-9, Seocho-Dong, Seocho Ku, Seoul, KOREA  
TEL: (02) 3486-8855

#### MALAYSIA

**Roland Asia Pacific Sdn. Bhd.**  
45-1, Block C2, Jalan PJU 1/39, Dataran Prima, 47301 Petaling Jaya, Selangor, MALAYSIA  
TEL: (03) 7805-3263

#### PHILIPPINES

**G.A. Yupangco & Co. Inc.**  
339 Gil J. Puyat Avenue Makati, Metro Manila 1200, PHILIPPINES  
TEL: (02) 899 9801

#### SINGAPORE

**SWEET LEE MUSIC COMPANY PTE. LTD.**  
150 Sims Drive, SINGAPORE 387381  
TEL: 6846-3676

#### SRI LANKA

**Penguin Electronics (Pvt) Ltd.**  
115, Maya Avenue, Colombo 06, SRI LANKA  
TEL: (11) 2552376

#### TAIWAN

**ROLAND TAIWAN ENTERPRISE CO., LTD.**  
Room 5, 9th Fl. No. 112 Chung Shan N.Road Sec.2, Taipei, TAIWAN, R.O.C.  
TEL: (02) 2561 3339

#### THAILAND

**Theera Music Co., Ltd.**  
330 Soi Vergn NakornKasem, New Road, Sumpantawongse, Bangkok 10100, THAILAND  
TEL: (02) 224-8821

#### VIETNAM

**SAIGON MUSIC DISTRIBUTOR (TAN DINH MUSIC)**  
138 Tran Quang Khai Street Dist. 1, Ho Chi Minh City VIETNAM  
TEL: (08) 848-4068

### AUSTRALIA/NEW ZEALAND

#### AUSTRALIA/NEW ZEALAND

**Roland Corporation Australia Pty., Ltd.**  
38 Campbell Avenue Dee Why West. NSW 2099 AUSTRALIA

**For Australia**  
Tel: (02) 9982 8266  
**For New Zealand**  
Tel: (09) 3098 715

### CENTRAL/LATIN AMERICA

#### ARGENTINA

**Instrumentos Musicales S.A.**  
Av.Santa Fe 2055 (1123) Buenos Aires ARGENTINA  
TEL: (011) 4508-2700

#### BARBADOS

**A&B Music Supplies LTD**  
12 Webster Industrial Park Wildey, St.Michael, Barbados  
TEL: (246)430-1100

#### BRAZIL

**Roland Brasil Ltda.**  
Rua San Jose, 780 Sala B Parque Industrial San Jose Cotia - Sao Paulo - SP, BRAZIL  
TEL: (011)4615 5666

#### CHILE

**Comercial Fancy II S.A.**  
Rut.: 96.919.420-1 Nataniel Cox #739, 4th Floor Santiago - Centro, CHILE  
TEL: (02) 688-9540

#### COLOMBIA

**Centro Musical Ltda.**  
Cra 43 B No 25 A 41 Bododega 9 Medellin, Colombia  
TEL: (574)3812529

#### COSTA RICA

**JUAN Bansbach Instrumentos Musicales**  
Ave.1. Calle 11, Apartado 10237, San Jose, COSTA RICA  
TEL: 258-0211

#### CURACAO

**Zeelandia Music Center Inc.**  
Orionweg 30 Curacao, Netherland Antilles  
TEL:(305)5926866

#### DOMINICAN REPUBLIC

**Instrumentos Fernando Giraldez**  
Calle Proyecto Central No.3 Ens. La Esperilla Santo Domingo, Dominican Republic  
TEL:(809) 683 0305

#### ECUADOR

**Mas Musica**  
Rumichaca 822 y Zaruma Guayaquil - Ecuador  
TEL:(593-4)2302364

#### EL SALVADOR

**OMNI MUSIC**  
75 Avenida Norte y Final Alameda Juan Pablo II, Edificio No.4010 San Salvador, EL SALVADOR  
TEL: 262-0788

#### GUATEMALA

**Casa Instrumental**  
Calleza Roosevelt 34-01,zona 11 Ciudad de Guatemala Guatemala  
TEL:(502) 599-2888

#### HONDURAS

**Almacen Pajaro Azul S.A. de C.V.**  
BO.Paz Barahona 3 Ave.11 Calle S.O San Pedro Sula, Honduras  
TEL: (504) 553-2029

#### MARTINIQUE

**Musique & Son**  
Z.I.Les Mangle 97232 Le Lamantin Martinique F.W.I.  
TEL: 596 596 426860

#### Gigamus SARL

10 Rte De La Folie 97200 Fort De France Martinique F.W.I.  
TEL: 596 596 715222

#### MEXICO

**Casa Veerkamp, s.a. de c.v.**  
Av. Toluca No. 323, Col. Olivar de los Padres 01780 Mexico D.F. MEXICO  
TEL: (55) 5668-6699

#### NICARAGUA

**Bansbach Instrumentos Musicales Nicaragua**  
Altamira D'Este Calle Principal de la Farmacia 5ta.Avenida 1 Cuadra al Lago.#503 Managua, Nicaragua  
TEL: (505)277-2557

#### PANAMA

**SUPRO MUNDIAL, S.A.**  
Boulevard Andrews, Albrook, Panama City, REP. DE PANAMA  
TEL: 315-0101

#### PARAGUAY

**Distribuidora De Instrumentos Musicales**  
J.E. Olear y ESQ. Manduvira Asuncion PARAGUAY  
TEL: (595) 21 492147

#### PERU

**Audionet**  
Distribuciones Musicales SAC Juan Fanning 530 Miraflores Lima - Peru  
TEL: (511) 4461388

#### TRINIDAD

**AMR Ltd**  
Ground Floor Maritime Plaza Barataria Trinidad W.I.  
TEL: (868) 638 6385

#### URUGUAY

**Todo Musica S.A.**  
Francisco Acuna de Figueroa 1771 C.P.: 11.800 Montevideo, URUGUAY  
TEL: (02) 924-2335

#### VENEZUELA

**Instrumentos Musicales Allegro,C.A.**  
Av.las industrias edf.Guitar import #7 zona Industrial de Turumo Caracas, Venezuela  
TEL: (212) 244-1122

### EUROPE

#### AUSTRIA

**Roland Elektronische Musikinstrumente HmbH. Austrian Office**  
Eduard-Bodem-Gasse 8, A-6020 Innsbruck, AUSTRIA  
TEL: (0512) 26 44 260

#### BELGIUM/FRANCE/

**HOLLAND/ LUXEMBOURG**  
**Roland Central Europe N.V.**  
Houtstraat 3, B-2260, Oevel (Westerlo) BELGIUM  
TEL: (014) 575811

#### CZECH REP.

**K-AUDIO**  
Kardasovska 626, CZ-198 00 Praha 9, CZECH REP.  
TEL: (2) 666 10529

#### DENMARK

**Roland Scandinavia A/S**  
Nordhavnsvej 7, Postbox 880, DK-2100 Copenhagen DENMARK  
TEL: 3916 6200

#### FINLAND

**Roland Scandinavia As, Filial Finland**  
Elanontie 5 FIN-01510 Vantaa, FINLAND  
TEL: (09) 68 24 020

#### GERMANY

**Roland Elektronische Musikinstrumente HmbH.**  
Oststrasse 96, 22844 Norderstedt, GERMANY  
TEL: (040) 52 60090

#### GREECE/CYPRUS

**STOLLAS S.A.**  
Music Sound Light 155, New National Road Patras 26442, GREECE  
TEL: 2610 435400

#### HUNGARY

**Roland East Europe Ltd.**  
Warehouse Area 'DEPO' Pf.83 H-2046 Torokbalint, HUNGARY  
TEL: (23) 511011

#### IRELAND

**Roland Ireland**  
G2 Calmount Park, Calmount Avenue, Dublin 12 Republic of IRELAND  
TEL: (01) 4294444

#### ITALY

**Roland Italy S. p. A.**  
Viale delle Industrie 8, 20020 Arese, Milano, ITALY  
TEL: (02) 937-78300

#### NORWAY

**Roland Scandinavia Adv. Kontor Norge**  
Lilleakerveien 2 Postboks 95 Lilleaker N-0216 Oslo NORWAY  
TEL: 2273 0074

#### POLAND

**MX MUSIC SP.Z.O.O.**  
UL. Gibraltaraska 4, PL-03664 Warszawa POLAND  
TEL: (022) 679 44 19

#### PORTUGAL

**Roland Iberia, S.L. Portugal Office**  
Cais das Pedras, 8/9-1 Dto 4050-465, Porto, PORTUGAL  
TEL: 22 608 00 60

#### ROMANIA

**FBS LINES**  
Piata Libertatii 1, 535500 Gheorgheni, ROMANIA  
TEL: (266) 364 609

#### RUSSIA

**MuTek**  
Dorozhnaya ul.3,korp.6 117 545 Moscow, RUSSIA  
TEL: (095) 981-4967

#### SPAIN

**Roland Iberia, S.L.**  
Paseo Garcia Faria, 33-35 08005 Barcelona SPAIN  
TEL: 93 493 91 00

#### SWEDEN

**Roland Scandinavia A/S SWEDISH SALES OFFICE**  
Danvik Center 28, 2 tr. S-131 30 Nacka SWEDEN  
TEL: (08) 702 00 20

#### SWITZERLAND

**Roland (Switzerland) AG**  
Landstrasse 5, Postfach, CH-4452 Itingen, SWITZERLAND  
TEL: (061) 927-8383

#### UKRAINE

**TIC-TAC**  
Mira Str. 19/108 P.O. Box 180 295400 Munkachevo, UKRAINE  
TEL: (03131) 414-40

#### UNITED KINGDOM

**Roland (U.K.) Ltd.**  
Atlantic Close, Swansea Enterprise Park, SWANSEA SA7 9FJ, UNITED KINGDOM  
TEL: (01792) 702701

### MIDDLE EAST

#### BAHRAIN

**Moon Stores**  
No.16, Bab Al Bahrain Avenue, P.O.Box 247, Manama 304, CANADA  
TEL: 17 211 005

#### IRAN

**MOCO INC.**  
No.41 Nike St., Dr.Shariyati Ave., Roberoye Cerahe Mirdamad Tehran, IRAN  
TEL: (021) 285-4169

#### ISRAEL

**Halilit P. Greenspoon & Sons Ltd.**  
8 Retzif Ha'aliya Hashnya St. Tel-Aviv-Yafo ISRAEL  
TEL: (03) 6823666

#### JORDAN

**MUSIC HOUSE CO. LTD. FREDDY FOR MUSIC**  
P..O. Box 922846 Amman 11192 JORDAN  
TEL: (06) 5692866

#### KUWAIT

**EASA HUSAIN AL-YOUSIFI & SONS CO.**  
Abdullah Salem Street, Safat, KUWAIT  
TEL: 243-6399

#### LEBANON

**Chahine S.A.L.**  
Gerge Zeidan St., Chahine Bldg., Achrafieh, P.O.Box: 16-5857 Beirut, LEBANON  
TEL: (01) 20-1441

#### OMAN

**TALENTZ CENTRE L.L.C.**  
Malatan House No.1 Al Noor Street, Ruwi SULTANATE OF OMAN  
TEL: 2478 3443

#### QATAR

**Al Emadi Co. (Badie Studio & Stores)**  
P.O. Box 62, Doha, QATAR  
TEL: 4423-554

#### SAUDI ARABIA

**aDawlah Universal Electronics APL**  
Corniche Road, Aldossary Bldg., 1st Floor, Alkhubar, SAUDI ARABIA

P.O.Box 2154, Alkhubar 31952

**SAUDI ARABIA**  
TEL: (03) 898 2081

#### SYRIA

**Technical Light & Sound Center**  
Rawda, Abdul Qader Jazairi St. Bldg. No. 21, P.O.BOX 13520, Damascus, SYRIA  
TEL: (011) 223-5384

#### TURKEY

**ZUHAL DIS TICARET A.S.**  
Galip Dede Cad. No.37 Beyoglu - Istanbul / TURKEY  
TEL: (0212) 249 85 10

#### U.A.E.

**Zak Electronics & Musical Instruments Co. L.L.C.**  
Zabeel Road, Al Sherooq Bldg., No. 14, Grand Floor, Dubai, U.A.E.  
TEL: (04) 3360715

### NORTH AMERICA

#### CANADA

**Roland Canada Ltd. (Head Office)**  
5480 Parkwood Way Richmond B. C., V6V 2M4 CANADA  
TEL: (604) 270 6626

#### Roland Canada Ltd.

**(Toronto Office)**  
170 Admiral Boulevard Mississauga On L5T 2N6 CANADA  
TEL: (905) 362 9707

#### U. S. A.

**Roland Corporation U.S.**  
5100 S. Eastern Avenue Los Angeles, CA 90040-2938, U. S. A.  
TEL: (323) 890 3700

As of April 1, 2006 (ROLAND)



04237345

06-08-2N